



Alu-made by

Pergola | Abris | Mobilier de jardin



COLLECTION 2023

PERGOLA

ABRIS

SALON DE JARDIN

CHAUFFAGE
DE TERRASSE
(À GRANULÉS)





CARPORT

MOBILIER DE JARDIN

COFFRE DE RANGEMENT

SOMMAIRES



PERGOLA

BIOCLIMATIQUE | P08



TOILE | P14



POLYCARBONATE | P18



ABRIS

ABRI DE SPA | P23



CARPORT | P27



ABRI PLUS | P36



MOBILIER DE JARDIN

CUISINE & DESSERTS
EXTÉRIEUR | P72



TABLES | P74



CHAISE | P82





*Voir CGV

ABRI DE RANGEMENT | P40



ABRI DE JARDIN | P48



GARAGE | P60



POOL HOUSE | P66



ABRI POUBELLE | P68



BAINS DE SOLEIL | P84



SALON DE JARDIN | P86



COFFRE DE RANGEMENT | P88



CHAUFFAGE DE TERRASSE | P92







PERGOLA

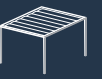

08 BIOCLIMATIQUE



08
Marbella
Pergola adossée



09
Marbella
Pergola autoportée



10
Ibiza
Pergola adossée



11
Ibiza
Pergola autoportée



12
Store vertical
Option



13
Baie vitrée
Option



14
Rideau de verre
Option

15 TOILE



15
Caraïbes
Pergola autoportée



16
Bermudes
Pergola autoportée



17
Antilles
Pergola autoportée

18 POLYCARBONATE



18
New York
Pergola autoportée



19
Brooklyn
Pergola autoportée



20
Bronx
Pergola adossée



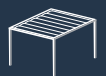

MARBELLA | Pergola bioclimatique adossée



CARACTÉRISTIQUES

- Pergola adossée en aluminium
- Poteau 100x100 mm
- Poutre gouttière 137x100 mm
- Aluminium thermolaqué Qualicoat / Qualimarine / Qualanod
- Lame blanche simple parois 212 mm
- Platine de fixation au sol
- Vis de fixation fournies
- Ouverture et fermeture à l'aide d'une manivelle
- Option pack motorisé lame + led
- Option pack motorisé store

COULEURS DISPONIBLES

Structure



OPTIONS*

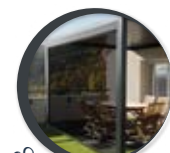

Store verticale

*Voir le détail p12



Baie coulissante

*Voir le détail p13



Rideau de verre

*Voir le détail p14

DIMENSIONS

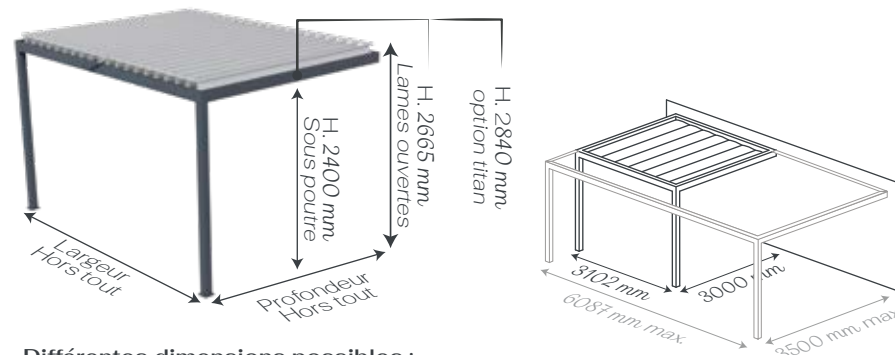

Différentes dimensions possibles :

- P. 3000 x L. 3102 x H. 2400 mm
- P. 3000 x L. 4097 x H. 2400 mm
- P. 3000 x L. 5092 x H. 2400 mm
- P. 3000 x L. 6087 x H. 2400 mm
- P. 3500 x L. 4097 x H. 2400 mm
- P. 3500 x L. 5092 x H. 2400 mm
- P. 3500 x L. 6087 x H. 2400 mm

LAME ORIENTABLE

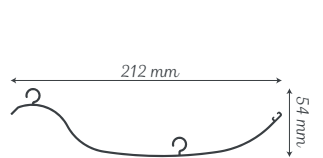

GOUTTIÈRE

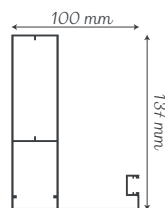

POTEAU

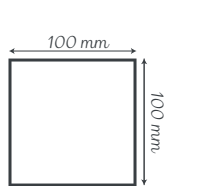

PLATINE AU SOL

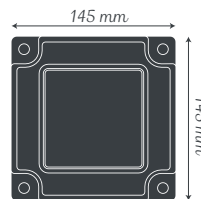

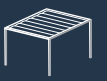

MARBELLA | Pergola bioclimatique autoportée



LAME ORIENTABLE

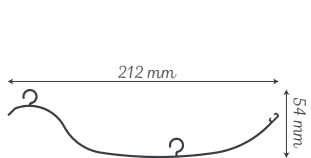

GOUTTIÈRE

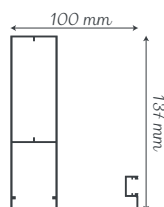

POTEAU

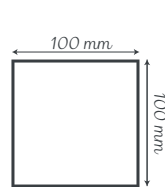

PLATINE AU SOL

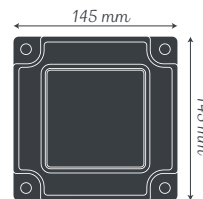

CARACTÉRISTIQUES

- Pergola adossée en aluminium
- Poteau 100x100 mm
- Poutre gouttière 137x100 mm
- Aluminium thermolaqué Qualicoat / Qualmarine / Qualanod
- Lame blanche simple parois 212 mm
- Platine de fixation au sol
- Vis de fixation fournies
- Ouverture et fermeture à l'aide d'une manivelle
- Option pack motorisé lame + led
- Option pack motorisé store

COULEURS DISPONIBLES

Structure



OPTIONS*

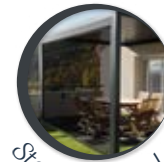

Store verticale

*Voir le détail p12



Baie coulissante

*Voir le détail p13



Rideau de verre

*Voir le détail p14

DIMENSIONS

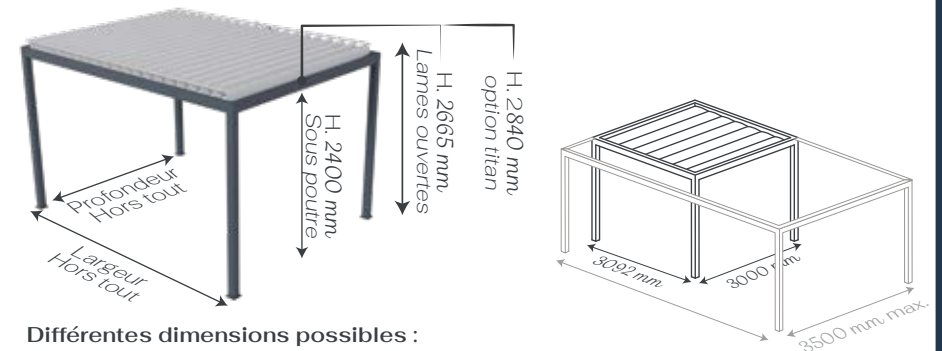

Différentes dimensions possibles :

- P. 3000 x L. 3092 x H. 2400 mm
- P. 3000 x L. 4087 x H. 2400 mm
- P. 3000 x L. 5082 x H. 2400 mm
- P. 3000 x L. 6077 x H. 2400 mm
- P. 3500 x L. 4087 x H. 2400 mm
- P. 3500 x L. 5082 x H. 2400 mm
- P. 3500 x L. 6077 x H. 2400 mm

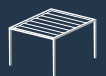

IBIZA | Pergola bioclimatique adossée



CARACTÉRISTIQUES

- Pergola adossée en aluminium
- Poteau 154x154 mm
- Poutre gouttière 150x260 mm
- Aluminium thermolaqué Qualicoat / Qualimarine / Qualanod
- Lame blanche double parois 211 mm
- Platine de fixation au sol avec évacuation de l'eau intégrée
- Ouverture et fermeture à l'aide d'une manivelle
- Option pack motorisé lame + led
- Option pack motorisé store

COULEURS DISPONIBLES



OPTIONS*

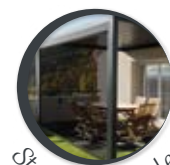

Store verticale

*Voir le détail p12



Baie coulissante

*Voir le détail p13



Rideau de verre

*Voir le détail p14

DIMENSIONS

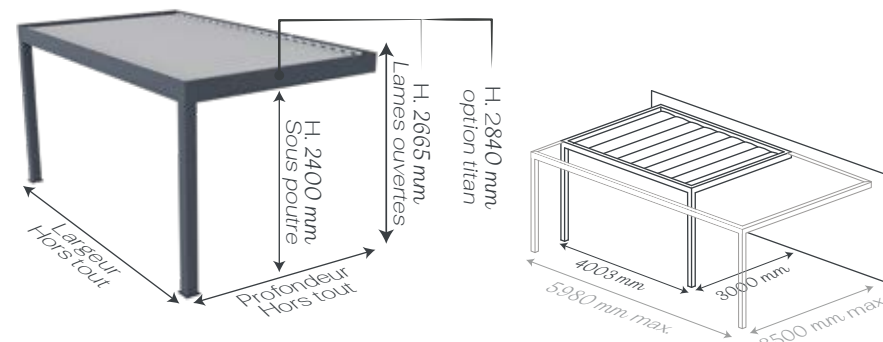

Différentes dimensions possibles :

- P. 3500 x L. 4003 x H. 2400 mm
- P. 3000 x L. 4992 x H. 2400 mm
- P. 3500 x L. 5980 TITAN x H. 2400 mm
- P. 3000 x L. 5980 TITAN x H. 2400 mm

LAME ORIENTABLE

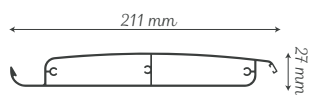

GOUTTIÈRE

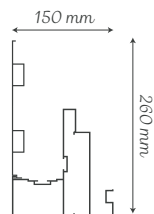

POTEAU

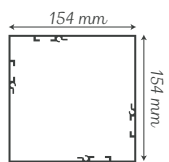

PLATINE AU SOL

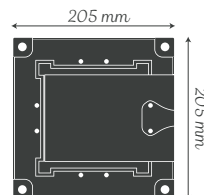

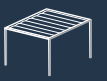

IBIZA | Pergola bioclimatique autoportée



CARACTÉRISTIQUES

- Pergola autoportante en aluminium
- Poteau 154x154 mm
- Poutre gouttière 150x260 mm
- Aluminium thermolaqué Qualicoat / Qualimarine / Qualanod
- Lame blanche double parois 211 mm
- Platine de fixation au sol
- Ouverture et fermeture à l'aide d'une manivelle
- Option pack motorisé lame + led
- Option pack motorisé store

COULEURS DISPONIBLES



OPTIONS*



Store verticale

*Voir le détail p12



Baie coulissante

*Voir le détail p13



Rideau de verre

*Voir le détail p14

DIMENSIONS

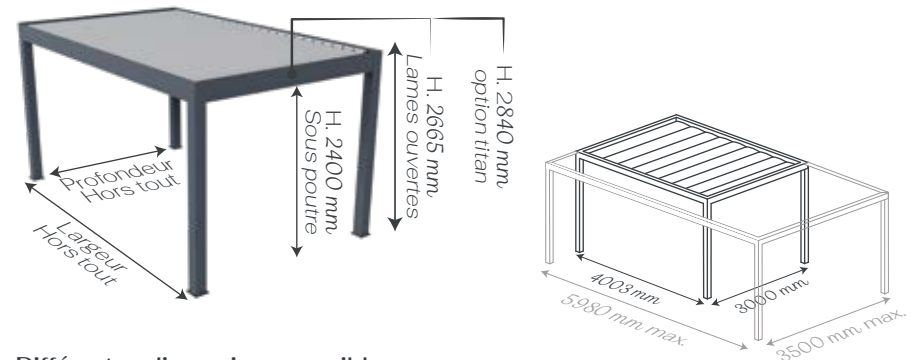

Différentes dimensions possibles :

- P. 3500 x L. 4003 x H. 2400 mm
- P. 3000 x L. 4992 x H. 2400 mm
- P. 3500 x L. 5980 TITAN x H. 2400 mm
- P. 3000 x L. 5980 TITAN x H. 2400 mm

LAME ORIENTABLE

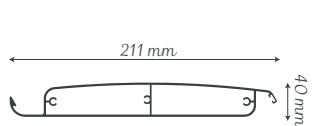

GOUTTIÈRE

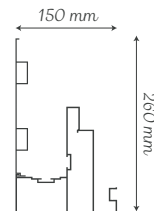

POTEAU

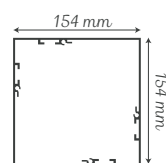

PLATINE AU SOL

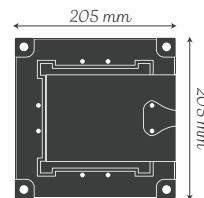

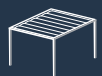

BIOCLIMATIQUE

STORE VERTICAL | Option



- Store vertical avec caisson 100 x 100 mm
- Joue latérale moulée
- Axe en acier galvanisé
- Lame finale avec joint epdm
- Coulisse extrudée
- Aluminium 100% recyclable
- Toile polyester 37%, PVC microperforé 53%
- Option pack motorisé

COULEURS DISPONIBLES

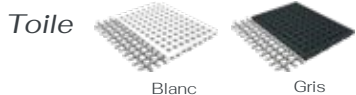

CAISSON 100 mm

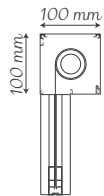

COULISSE

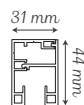

DIMENSIONS

Réf. Marbella

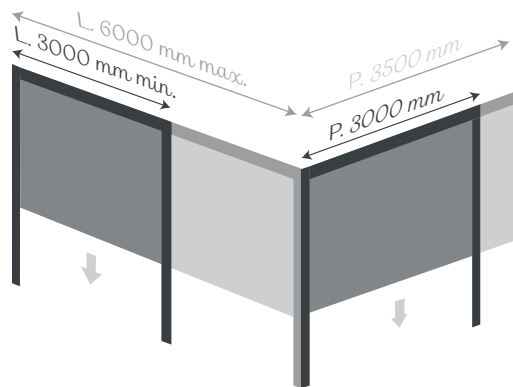

Réf. Ibiza

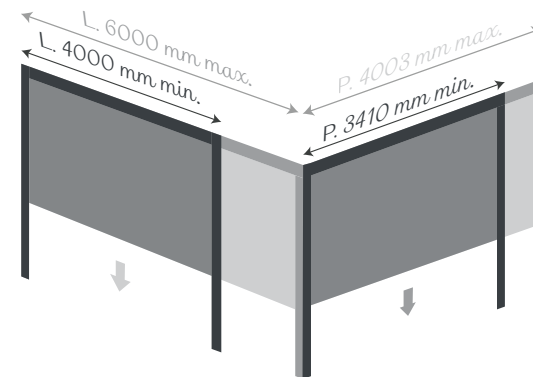

Différentes dimensions possibles :

Références	Côtes extérieurs de la pergola (dimensions en mm)	Côtes intérieurs de la pergola (dimensions en mm)
Réf. Stomar 1	Latéral 3000 adossé	2902 x 2400
Réf. Stomar 2	Latéral 3500 adossé	3402 x 2400
Réf. Stomar 3	Latéral 3000 autoporté	2804 x 2400
Réf. Stomar 4	Latéral 3500 autoporté	3304 x 2400
Réf. Stomar 5	Façade 3102 adossé	2906 x 2400
Réf. Stomar 6	Façade 4097 adossé	3901 x 2400
Réf. Stomar 7	Façade 5092 adossé	4896 x 2400
Réf. Stomar 8	Façade 6087 adossé	5891 x 2400
Réf. Stomar 9	Façade 3102 autoporté	2896 x 2400
Réf. Stomar 10	Façade 4087 autoporté	3891 x 2400
Réf. Stomar 11	Façade 5082 autoporté	4886 x 2400
Réf. Stomar 12	Façade 6077 autoporté	5881 x 2400

Différentes dimensions possibles :

Références	Côtes extérieurs de la pergola (dimensions en mm)	Côtes intérieurs de la pergola (dimensions en mm)
Réf. Stoibi 1	Latéral 3000 adossé	2849 x 2400
Réf. Stoibi 2	Latéral 3500 adossé	3349 x 2400
Réf. Stoibi 3	Latéral 3000 autoporté	2698 x 2400
Réf. Stoibi 4	Latéral 3500 autoporté	3198 x 2400
Réf. Stoibi 5	Façade 4003	3701 x 2400
Réf. Stoibi 6	Façade 4992	4690 x 2400
Réf. Stoibi 7	Façade 5980	5678 x 2400

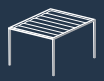

BAIE VITRÉE | Option



DIMENSIONS

Réf. Marbella

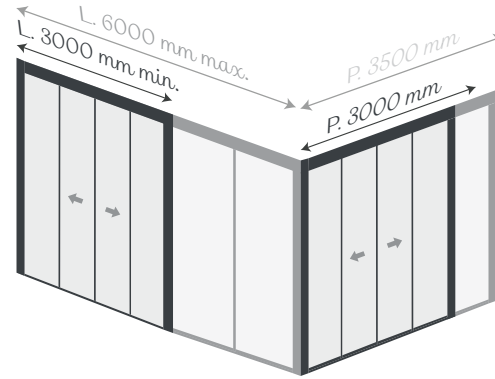

Réf. Ibiza

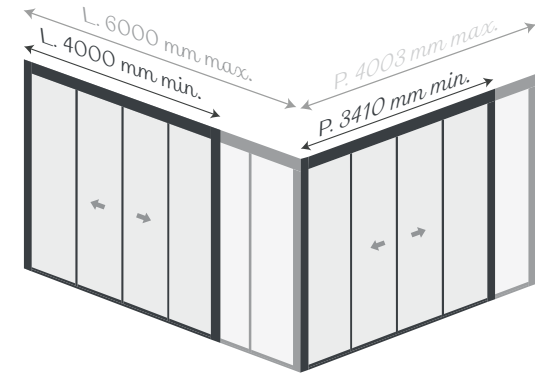

- 4 vantaux et double vitrage
- Fermeture aluminium sans rupture de pont thermique
- Vitrage 4.8.4 double vitrage
- 2 rails 50% ouverture serrure un point

Différentes dimensions possibles :

Références	Côtes extérieurs de la pergola (dimensions en mm)	Côtes intérieurs de la pergola (dimensions en mm)
Réf. Baimar 1	Latéral 3000 adossé	2902 x 2400
Réf. Baimar 2	Latéral 3500 adossé	3402 x 2400
Réf. Baimar 3	Latéral 3000 autoporté	2804 x 2400
Réf. Baimar 4	Latéral 3500 autoporté	3304 x 2400
Réf. Baimar 5	Façade 3102 adossé	2906 x 2400
Réf. Baimar 6	Façade 4097 adossé	3901 x 2400
Réf. Baimar 7	Façade 5092 adossé	4896 x 2400
Réf. Baimar 8	Façade 6087 adossé	5891 x 2400
Réf. Baimar 9	Façade 3102 autoporté	2896 x 2400
Réf. Baimar 10	Façade 4087 autoporté	3891 x 2400
Réf. Baimar 11	Façade 5082 autoporté	4886 x 2400
Réf. Baimar 12	Façade 6077 autoporté	5881 x 2400

COULEURS DISPONIBLES



Différentes dimensions possibles :

Références	Côtes extérieurs de la pergola (dimensions en mm)	Côtes intérieurs de la pergola (dimensions en mm)
Réf. Baiibi 1	Latéral 3000 adossé	2849 x 2400
Réf. Baiibi 2	Latéral 3500 adossé	3349 x 2400
Réf. Baiibi 3	Latéral 3000 autoporté	2698 x 2400
Réf. Baiibi 4	Latéral 3500 autoporté	3198 x 2400
Réf. Baiibi 5	Façade 4003	3701 x 2400
Réf. Baiibi 6	Façade 4992	4690 x 2400
Réf. Baiibi 7	Façade 5980	5678 x 2400

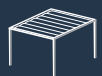

RIDEAU DE VERRE | Option



DIMENSIONS

Réf. Marbella

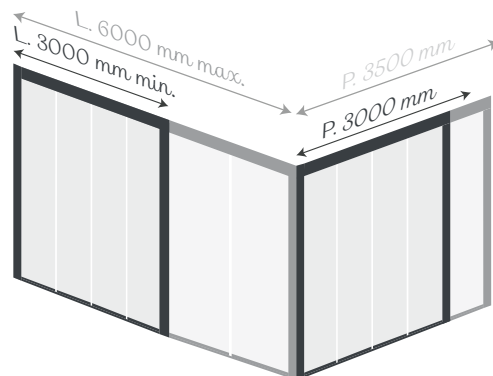

Réf. Ibiza

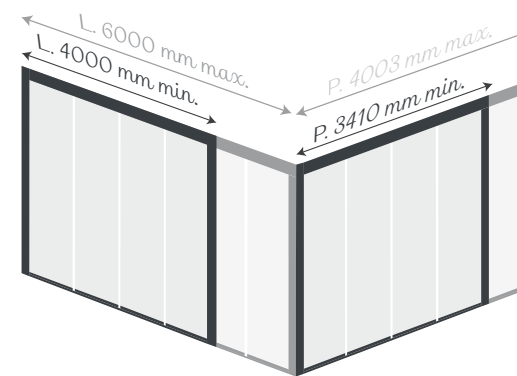

- Rideau de verre 55² feuilleté
- Structure en aluminium
- 4 vantaux
- 4 rails

Différentes dimensions possibles :

Références	Côtes extérieurs de la pergola (dimensions en mm)	Côtes intérieurs de la pergola (dimensions en mm)
Réf. Ridomar 1	Latéral 3000 adossé	2902 x 2400
Réf. Ridomar 2	Latéral 3500 adossé	3402 x 2400
Réf. Ridomar 3	Latéral 3000 autoporté	2804 x 2400
Réf. Ridomar 4	Latéral 3500 autoporté	3304 x 2400
Réf. Ridomar 5	Façade 3102 adossé	2906 x 2400
Réf. Ridomar 6	Façade 4097 adossé	3901 x 2400
Réf. Ridomar 7	Façade 5092 adossé	4896 x 2400
Réf. Ridomar 8	Façade 6087 adossé	5891 x 2400
Réf. Ridomar 9	Façade 3102 autoporté	2896 x 2400
Réf. Ridomar 10	Façade 4087 autoporté	3891 x 2400
Réf. Ridomar 11	Façade 5082 autoporté	4886 x 2400
Réf. Ridomar 12	Façade 6077 autoporté	5881 x 2400

Différentes dimensions possibles :

Références	Côtes extérieurs de la pergola (dimensions en mm)	Côtes intérieurs de la pergola (dimensions en mm)
Réf. Ridoibi 1	Latéral 3000 adossé	2849 x 2400
Réf. Ridoibi 2	Latéral 3500 adossé	3349 x 2400
Réf. Ridoibi 3	Latéral 3000 autoporté	2698 x 2400
Réf. Ridoibi 4	Latéral 3500 autoporté	3198 x 2400
Réf. Ridoibi 5	Façade 4003	3701 x 2400
Réf. Ridoibi 6	Façade 4992	4690 x 2400
Réf. Ridoibi 7	Façade 5980	5678 x 2400

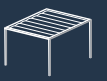

CARAÏBES | Pergola toile autoportée



CARACTÉRISTIQUES

- Pergola autoportante en aluminium
- Poteau 100x100 mm
- Poutre gouttière 137x100 mm
- Aluminium thermolaqué Qualicoat / Qualimarine / Qualanod
- Platine de fixation aluminium au sol
- Toile polyester 230grs imperméabilisée

COULEURS DISPONIBLES

Structure

9016
Blanc7016
Gris anthracite7036
Gris Métallique1019
Sablé Métallique2100
Noir

Toile

Gris
foncée

Ivoire

DIMENSIONS

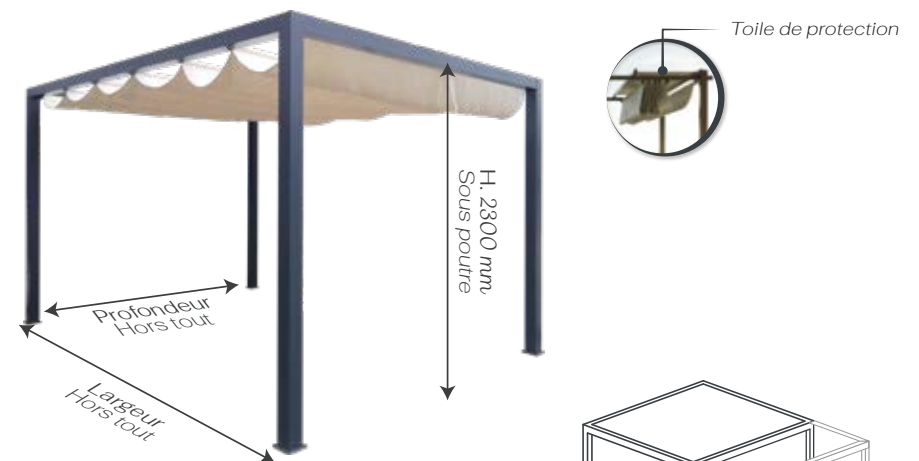

GOUTTIÈRE

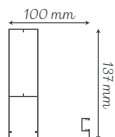

POTEAU

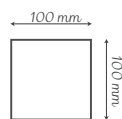

PLATINE AU SOL

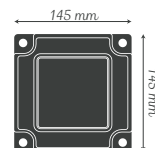

Différentes dimensions possibles :

- P. 3000 x L. 3000 x H. 2300 mm
- P. 3000 x L. 4000 x H. 2300 mm

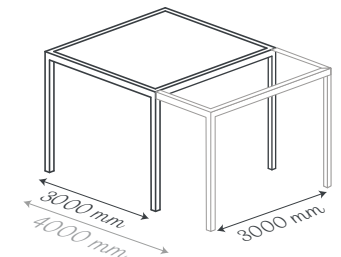

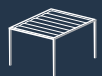

BERMUDES | Pergola toile autoportée



CARACTÉRISTIQUES

- Pergola autoportante en aluminium
- Poteau 100x100 mm
- Traverse 60x40 mm
- Aluminium thermolaqué Qualicoat / Qualimarine / Qualanod
- Platine de fixation aluminium au sol
- Toile polyester 230grs imperméabilisée

COULEURS DISPONIBLES

Structure



Toile



DIMENSIONS

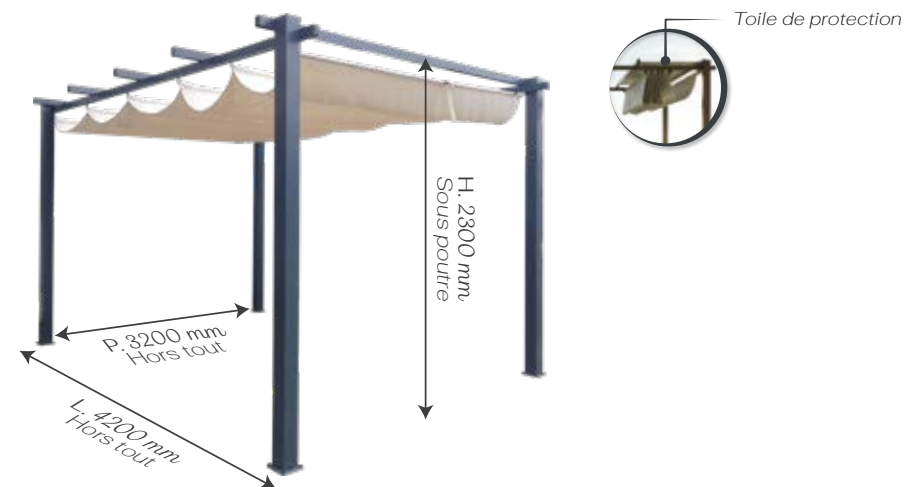

TRAVERSES

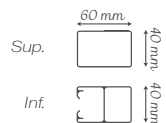

POTEAU

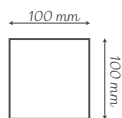

PLATINE AU SOL

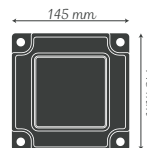

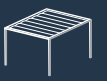

ANTILLES | Pergola toile autoportée



GOUTTIÈRE

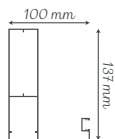

POTEAU

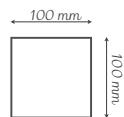

PLATINE AU SOL

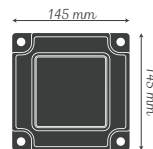

• Toile polyester 230grs imperméabilisée CARACTERISTIQUES

- Pergola autoportante en aluminium
- Poteau 100x100 mm
- Poutre gouttière 137x100 mm
- Aluminium thermolaqué Qualicoat / Qualimarine / Qualanod
- Platine de fixation aluminium au sol
- Toile polyester 230 grs imperméabilisée

COULEURS DISPONIBLES

Structure

9016
Blanc7016
Gris anthracite7036
Gris Métallique1019
Sablé Métallique2100
Noir

Toile

Gris
foncée

Ivoire

DIMENSIONS

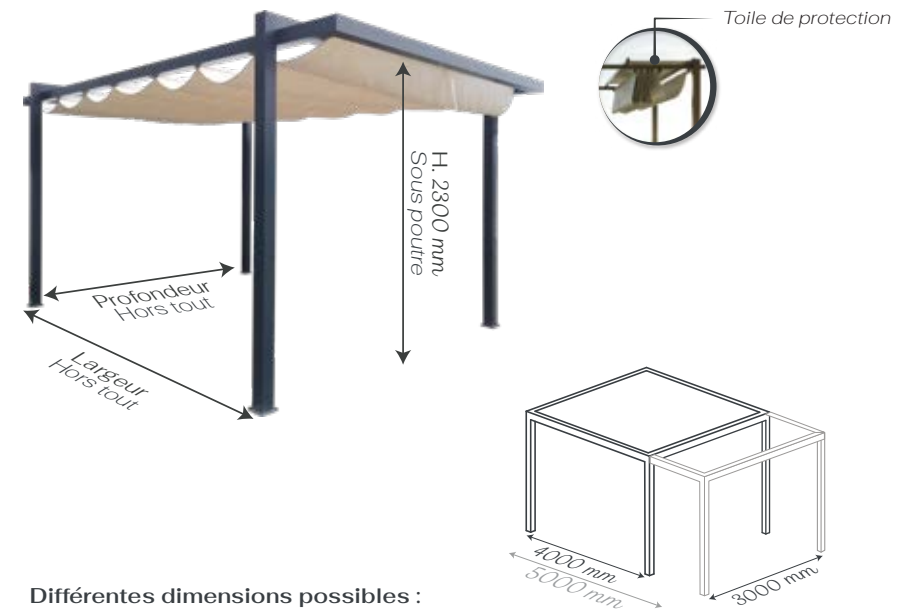

Différentes dimensions possibles :

- P. 3000 x L. 4000 x H. 2300 mm
- P. 3000 x L. 5000 x H. 2300 mm

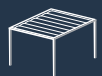

POLYCARBONATE

NEW YORK | Pergola polycarbonate cintré



CARACTÉRISTIQUES

- Pergola polycarbonate cintré en aluminium
- Poteau et faitière 68x43 mm
- Gouttière 93x34 mm
- Chevron extérieur 20x40 mm et chevron intermédiaire 40x40 mm
- Aluminium thermolaqué Qualicoat / Qualimarine / Qualanod
- Sortie de gouttière en polypropylène
- Polycarbonate opale 10 mm traité anti UV avec obturateur alu, adhésif microperforé largeur panneaux 930 mm
- Platine Abs fourni
- Vis de fixation fournies

COULEURS DISPONIBLES

Structure



DIMENSIONS

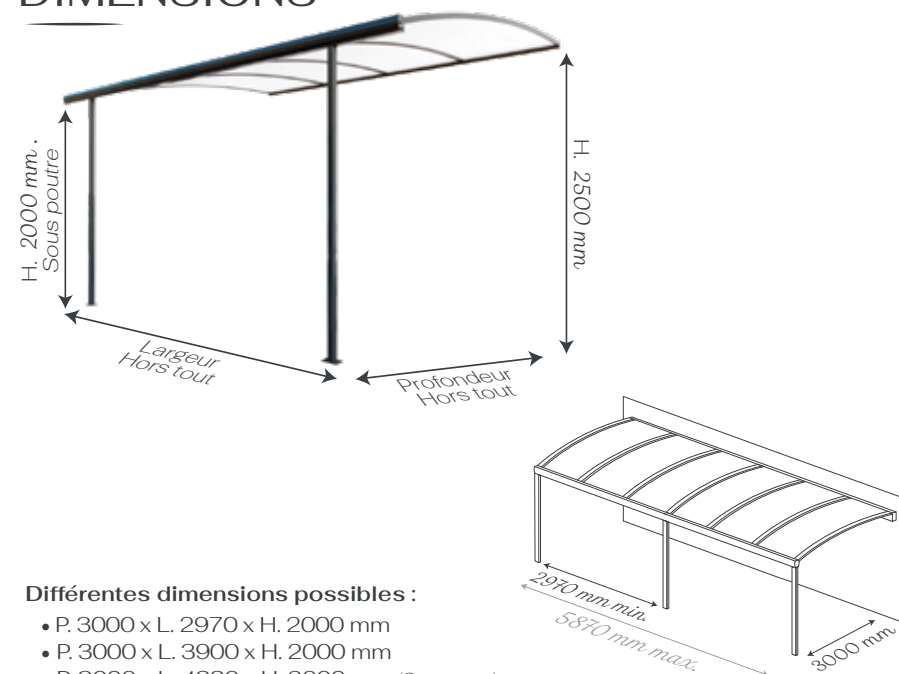

Différentes dimensions possibles :

- P. 3000 x L. 2970 x H. 2000 mm
- P. 3000 x L. 3900 x H. 2000 mm
- P. 3000 x L. 4880 x H. 2000 mm (3 poteaux)
- P. 3000 x L. 5870 x H. 2000 mm (3 poteaux)

CHEVRONS

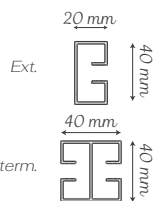

GOUTTIÈRE

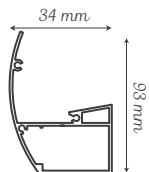

FAITIÈRE

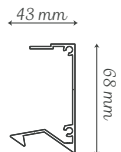

POTEAU

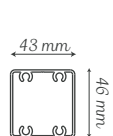

PLATINE AU SOL

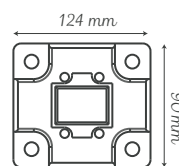

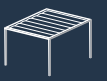

BROOKLYN | Pergola toile adossée



CARACTÉRISTIQUES

- Pergola polycarbonate en aluminium
- Poteau et faitière 80x43 mm
- Gouttière 141x93 mm
- Chevron 80x40 mm
- Aluminium thermolaqué Qualicoat / Qualimarine / Qualanod
- Polycarbonate opale 10 mm traité anti UV avec obturateur alu, adhésif microperforé
- Platine de fixation aluminium au sol
- Vis de fixation fournies

COULEURS DISPONIBLES

Structure



DIMENSIONS

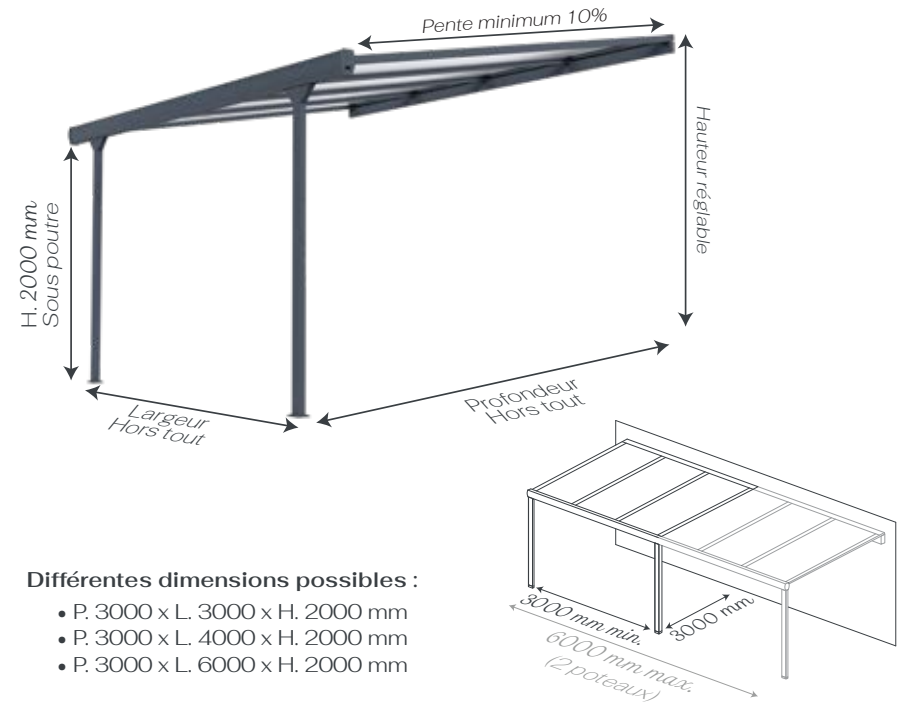

Différentes dimensions possibles :

- P. 3000 x L. 3000 x H. 2000 mm
- P. 3000 x L. 4000 x H. 2000 mm
- P. 3000 x L. 6000 x H. 2000 mm

CHEVRONS

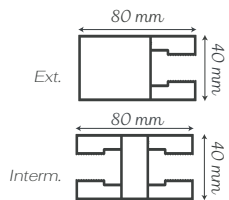

GOUTTIÈRE

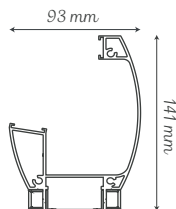

POTEAU

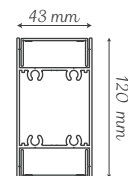

PLATINE AU SOL

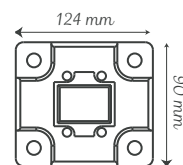

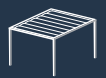

POLYCARBONATE

BRONX | Pergola polycarbonate



CARACTÉRISTIQUES

- Pergola polycarbonate réglable en aluminium
- Poteau et faitière 120x64 mm
- Gouttière 93x141mm
- Chevron 80x40 mm
- Aluminium thermolaqué Qualicoat / Qualimarine / Qualanod
- Polycarbonate opale 16mm traité anti UV avec obturateur alu, adhésif microperforé
- Platine de fixation aluminium au sol
- Vis de fixation fournies

COULEURS DISPONIBLES



DIMENSIONS

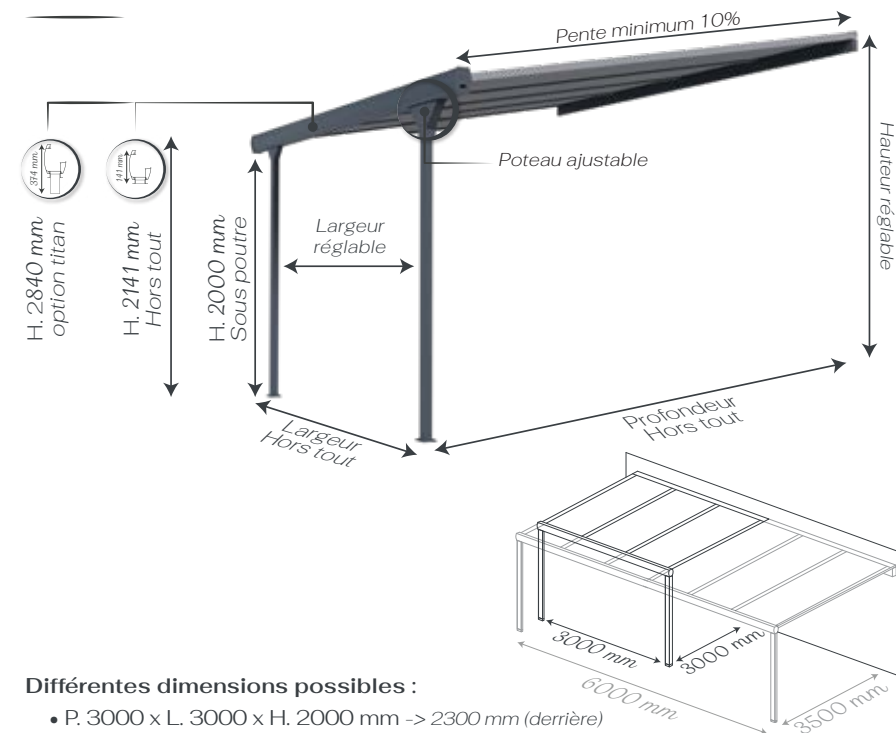

CHEVRONS

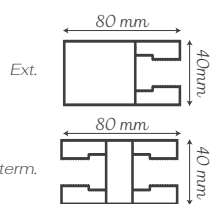

GOUTTIÈRE

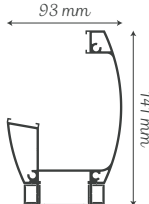

POTEAU

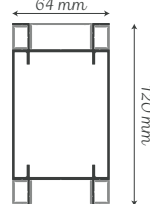

PLATINE AU SOL

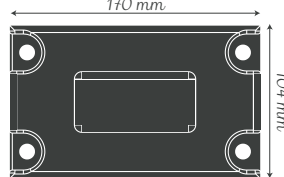

Différentes dimensions possibles :

- P. 3000 x L. 3000 x H. 2000 mm -> 2300 mm (derrière)
- P. 3000 x L. 4000 x H. 2000 mm -> 2300 mm (derrière)
- P. 3000 x L. 6000 x H. 2000 mm -> 2450 mm (derrière)
- P. 3500 x L. 6000 x H. 2000 mm -> 2500 mm (derrière)





24 ABRIS DE SPA



24
4pans spa 33



25
Toit plat spa 33



26
Poly spa 33

28 CARPORT



28
Carport vr53 & vr63



29
Carport 35 & 65



30
Carport poly 35



31
Carport toit 35



32
Carport toit plat avec dégagement



33
Carport cintré



34-35
Carport Grandlux Cintré & Design



36
Carport camping-car cintré

37 ABRIS PLUS



37
Garage&Abri



38
Carport&Abri

40 ABRIS DE RANGEMENT



40
Coffre de rangement XL



41
Pâquerette 22

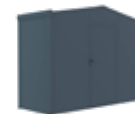

42
Aster



44
Iris



46
Eco Porto





ABRIS



48 ABRI DE JARDIN



48
Coquelicot



50
Bouton d'or



52
Trèfle



54
Marguerite 33/34



56
Pissenlit



58
Pensée

60 GARAGE



60
Poly-garage



62
Toit plat-garage



64
Double poly-garage



65
Double toit plat-garage

66 POOL HOUSE



66
Camomille

68 ABRI COFFRE DE RANGEMENT



68
Coffre de rangement XL



4PANS SPA 33



SURFACE



10,24 m²

POIDS



≈500 Kg

TOIT



4 Pans Polycarbonate
10 mm

CARACTÉRISTIQUES

- Abris pratique, isolé, étanche et robuste afin d'optimiser votre spa, grâce à ces lignes contemporaines.
- Structure du bati en aluminium, poteaux 100x100 mm
- Toiture en polycarbonate traité anti-vu, alvéolaire, 10 mm, clair, sur chevron en aluminium extrudé auto-drainant, section 80x40 mm, pente 10%. Les plaques de polycarbonate sont obturées par une protection microperforée et une protection renforcée en aluminium avec un système coupe-goutte
- Écoulement de l'eau par les gouttières périphériques en aluminium, sortie d'eau dans les angles
- Quatre baies coulissantes de quatre vantaux deux rails
- Nous vous conseillons de poser systématiquement une double grille d'aération pour chaque abris

COULEURS DISPONIBLES

Structure



9016
Blanc



7016
Gris anthracite



7036
Gris Métallique



1019
Sablé Métallique



2100
Noir

DIMENSIONS

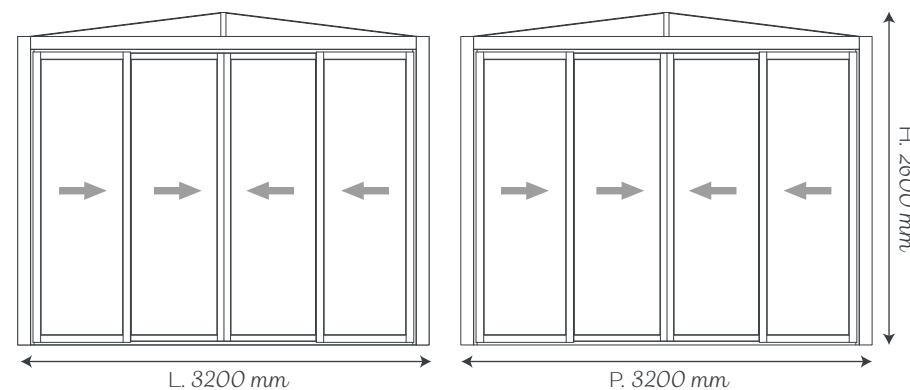



TOIT PLAT SPA 33



CARACTÉRISTIQUES

- Abris pratique, isolé, étanche et robuste afin d'optimisé votre spa, grâce à ces lignes contemporaines.
- Structure du bati en aluminium, poteaux 100x100 mm
- Toiture en panneaux acier laqué isolé avec mousse polyuréthane haute densité 30 mm avec double renfort
- Écoulement de l'eau par les gouttières périphériques aluminium, sortie d'eau dans les angles
- Quatre baies coulissantes de quatre vantaux deux rails
- Nous vous conseillons de poser systématiquement une double grille d'aération pour chaque abris

COULEURS DISPONIBLES

Structure



9016
Blanc



7016
Gris anthracite



7036
Gris Métallique



1019
Sablé Métallique



2100
Noir

DIMENSIONS

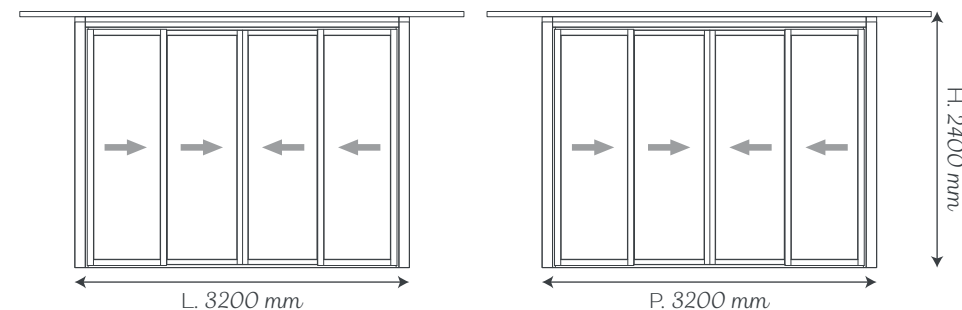

SURFACE



10,24 m²

POIDS



≈600 Kg

TOIT



Toit plat isolé
30mm



POLY SPA 33

ABRIS



CARACTÉRISTIQUES

- Abris pratique, isolé, étanche et robuste afin d'optimisé votre spa, grâce à ces lignes contemporaines.
- Structure du bati en aluminium, poteaux 100x100 mm
- Toiture en polycarbonate traité anti-vu, alvéolaire, 10 mm, clair, sur chevron en aluminium extrudé auto-drainant, section 40x40 mm, pente 10%. Les plaques de polycarbonate sont obturer par une protection microperforé et une protection renforcer en aluminium avec un système coupe goutte
- Écoulement de l'eau par les gouttières périphériques aluminium, sortie d'eau dans les angles
- Quatre baies coulissantes de quatre vantaux deux rails
- Nous vous conseillons de poser systématiquement une double grille d'aération pour chaque abris

COULEURS DISPONIBLES

Structure



DIMENSIONS

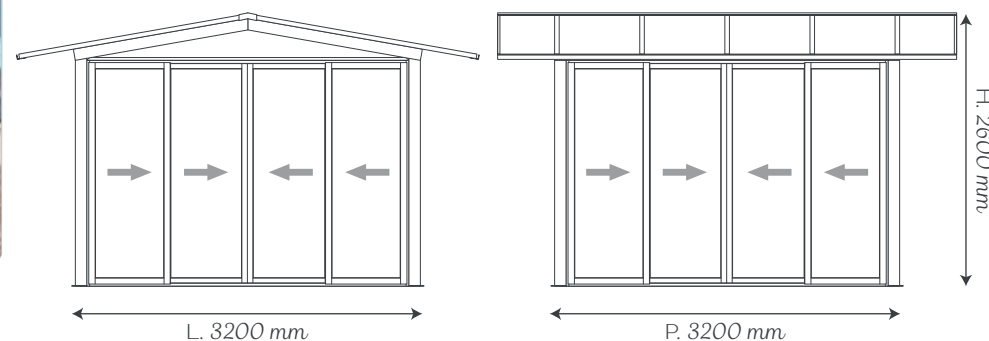

SURFACE



10,24 m²

POIDS



≈520 Kg

TOIT



2 Pans Polycarbonate
10 mm





CARPORT VR53 & VR63



ABRIS

CARACTÉRISTIQUES

- Carport pratique, isolé, étanche et robuste afin d'optimiser votre organisation et vos rangements, grâce à ces lignes contemporaines.
- Structure du bâti en aluminium, poteaux 100x100 mm
- Toiture en panneaux acier laqué isolé avec mousse polyuréthane haute densité 30mm avec double renfort
- Écoulement de l'eau par les gouttières périphériques aluminium, sortie d'eau dans les angles
- Portes de garage enroulable motorisé, lame 55 mm
- Nous vous conseillons de poser systématiquement une double grille d'aération pour chaque abris

COULEURS DISPONIBLES

Structure



DIMENSIONS

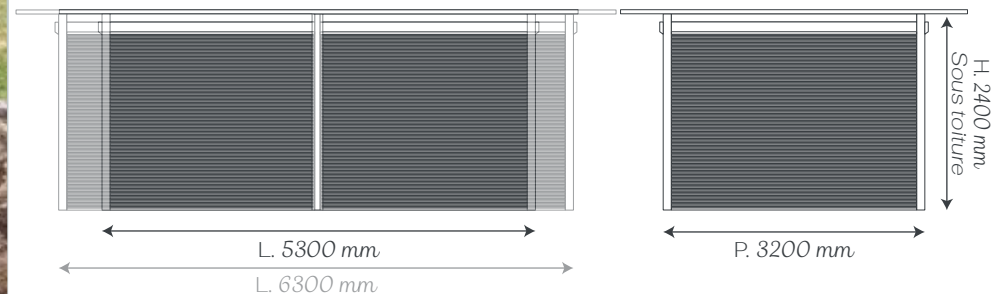

Différentes dimensions possibles :

- Réf. Carport vr53 : P. 3200 x L. 5300 x H. 2400 mm
- Réf. Carport vr63 : P. 3200 x L. 6300 x H. 2400 mm

SURFACE



16,96 m²
20,16 m²

POIDS



≈550 Kg
≈700 Kg

TOIT



Toit plat isolé
30mm



CARPORT 35 & 65



CARACTÉRISTIQUES

- Carport pratique, isolé, étanche et robuste afin d'optimiser votre organisation et vos rangements, grâce à ces lignes contemporaines.
- Structure du bâti en aluminium, poteaux 100x100 mm
- Toiture en panneaux acier laqué isolé avec mousse polyuréthane haute densité 30 mm avec double renfort
- Écoulement de l'eau par les gouttières périphériques aluminium, sortie d'eau dans les angles
- Nous vous conseillons de poser systématiquement une double grille d'aération pour chaque abris

COULEURS DISPONIBLES

Structure



DIMENSIONS

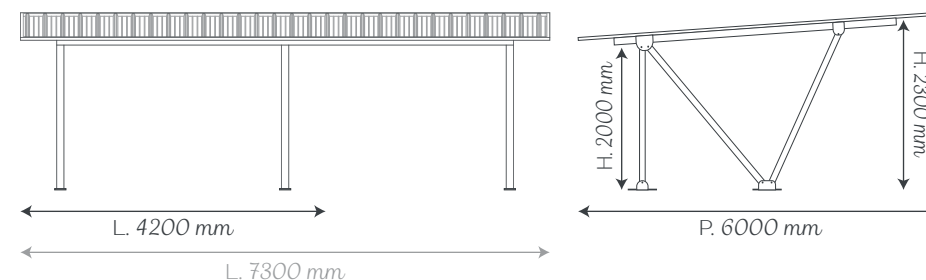

Différentes dimensions possibles :

- Réf. Carport 35 : P. 6000 x L. 4200 x H. 2300 mm
- Réf. Carport 65 : P. 6000 x L. 7300 x H. 2300 mm

SURFACE



16 m²
31,5 m²

POIDS



≈580 Kg
≈680 Kg

TOIT



Toit plat isolé
30mm



CARPORT POLY 35



ABRIS

CARACTÉRISTIQUES

- Carport pratique, isolé, étanche et robuste afin d'optimisé votre organisation et vos rangements, grâce à ces lignes contemporaines.
- Poteau et faitière 120x64 mm
- Gouttière 93x141mm
- Chevron 80x40 mm
- Aluminium thermolaqué Qualicoat / Qualimarine / Qualanod
- Polycarbonate translucide 10 mm traité anti UV avec obturateur alu, adhésif microperforé
- Platine de fixation aluminium au sol
- Vis de fixation fournies

COULEURS DISPONIBLES

Structure



DIMENSIONS

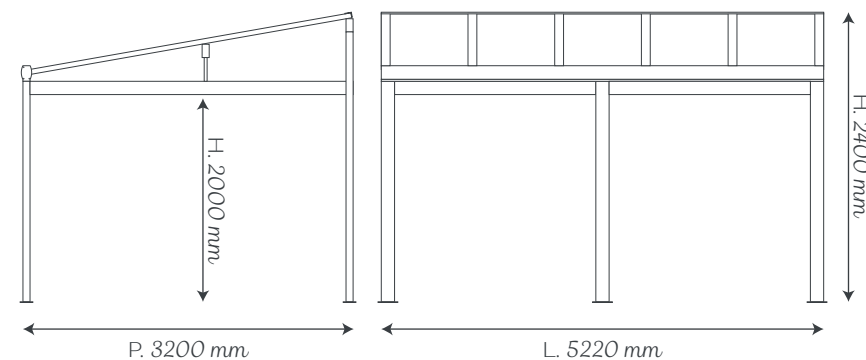

SURFACE



17,5 m²

POIDS



≈320 Kg

TOIT

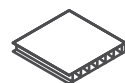

1 Pan Polycarbonate
16 mm



CARPORT TOIT 35



CARACTÉRISTIQUES

- Carport pratique, isolé, étanche et robuste afin d'optimiser votre organisation et vos rangements.
- Hauteur 2400 mm
- Section des poteaux et poutres 100x100mm
- Panneaux de toiture sandwich, isolée 30mm renforcé
- L'eau coule à travers les coins du toit
- Peinture label Qualicoat / Qualanod / Qualimarine

COULEURS DISPONIBLES

Structure

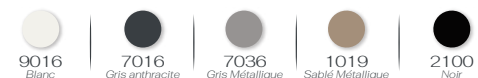

DIMENSIONS

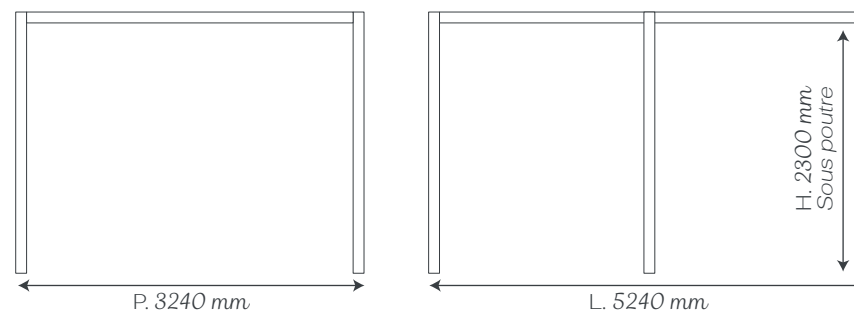

SURFACE

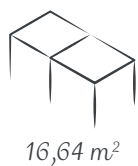

POIDS

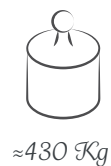

TOIT

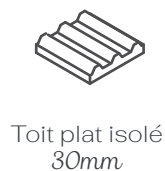

CARPORT TOIT PLAT AVEC DÉGAGEMENT



ABRIS

CARACTÉRISTIQUES

- Carport pratique, isolé, étanche et robuste afin d'optimisé votre organisation et vos rangements, grâce à ces lignes contemporaines.
- Montant et gouttière 100x100 mm
- Panneaux de toiture: Acier isolant 30 mm blanc
- Aluminium thermolaqué Qualicoat / Qualimarine / Qualanod
- Platine de fixation au sol
- Vis de fixation fournie
- Option dégagement coté gauche ou droit

COULEURS DISPONIBLES

Structure



DIMENSIONS

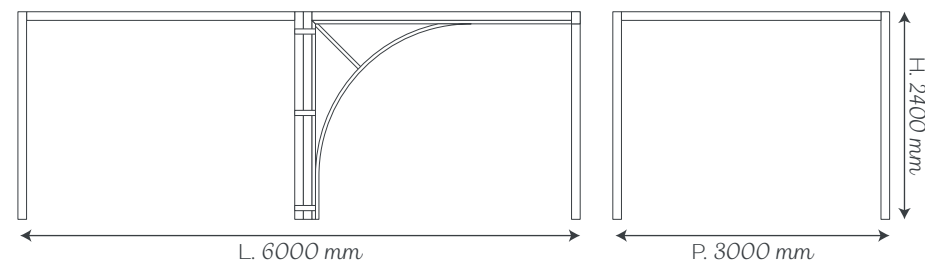

OPTIONS DÉGAGEMENT



Dégagement côté droit



Dégagement côté gauche

SURFACE

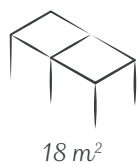

POIDS

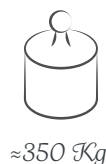

TOIT



Toit plat isolé
30mm



CARPORT CINTRÉ



CARACTÉRISTIQUES

- Carport pratique, isolé, étanche et robuste afin d'optimiser votre organisation et vos rangements, grâce à ces lignes contemporaines.
- Poteau 120x64 mm
- Chevron 80x40 mm
- Gouttière 93x141 mm
- Aluminium thermolaqué Qualicoat / Qualimarine / Qualanod
- Polycarbonate translucide 10 mm traité anti UV avec obturateur poly, adhésif microperforé
- Platine de fixation au sol

COULEURS DISPONIBLES

Structure



DIMENSIONS

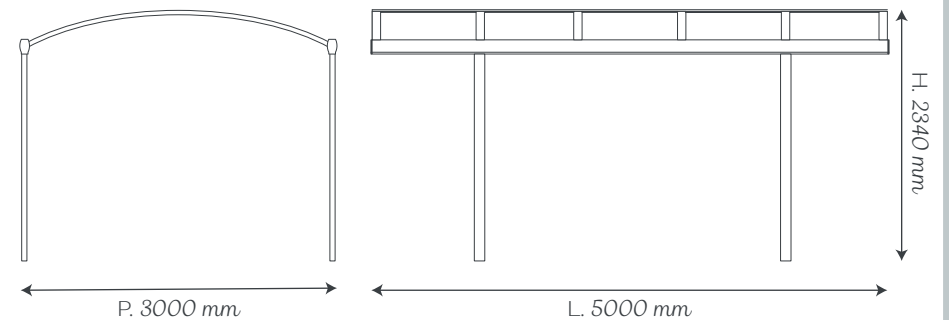

SURFACE

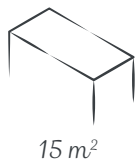

POIDS



TOIT



Polycarbonate cintré
10mm



CARPORT GRANDLUX CINTRÉ



ABRIS

CARACTÉRISTIQUES

- Carport pratique, isolé, étanche et robuste afin d'optimiser votre organisation et vos rangements, grâce à ces lignes contemporaines.
- Poteau 150x150 mm, Poutres 100x100 mm, Gouttière 93x141 mm, Chevron 80x40 mm
- Aluminium thermolaqué Qualicoat / Qualimarine / Qualanod
- Polycarbonate translucide 10 mm traité anti UV avec obturateur poly, adhésif microperforé
- Profil IPN à sceller au sol 800 mm
- Vis de fixation fournies

COULEURS DISPONIBLES

Structure



DIMENSIONS

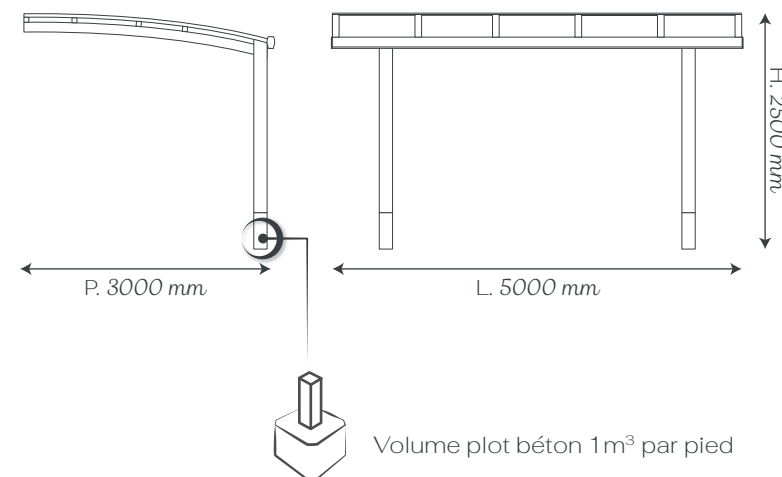

SURFACE

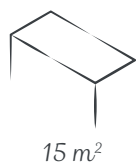

POIDS

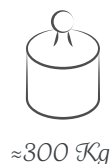

TOIT



Polycarbonate cintré
10mm



CARPORT GRANDLUX DESIGN



CARACTÉRISTIQUES

- Carport pratique, isolé, étanche et robuste afin d'optimiser votre organisation et vos rangements, grâce à ces lignes contemporaines.
- Poteau 150x150 mm, Poutres 100x100 mm, Chevron 80x40 mm
- Aluminium thermolaqué Qualicoat / Qualimarine / Qualanod
- Polycarbonate translucide 10 mm traité anti UV avec obturateur poly, adhésif microperforé
- Profil INP à sceller au sol 800 mm
- Vis de fixation fournies
- Kit led périphérique en option

COULEURS DISPONIBLES

Structure



9016
Blanc



7016
Gris anthracite



7036
Gris Métallique



1019
Sablé Métallique



2100
Noir

DIMENSIONS

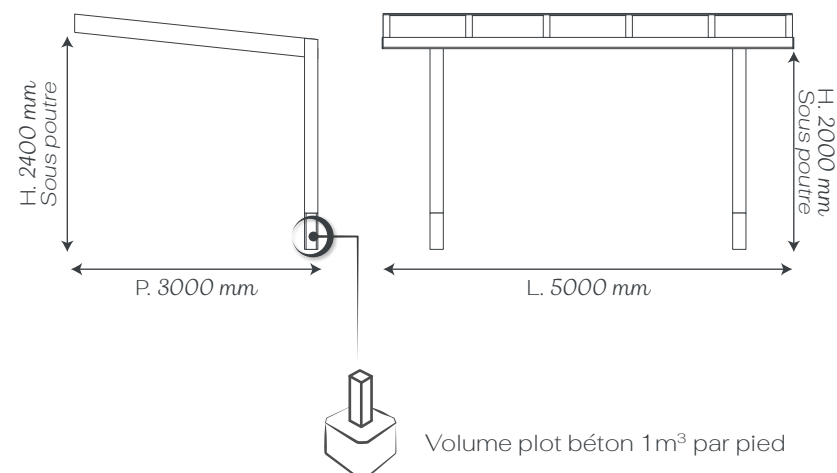

CARPORT CAMPING-CAR CINTRÉ



CARACTÉRISTIQUES

• Carport pratique, isolé, étanche et robuste afin d'optimiser votre organisation et vos rangements, grâce à ces lignes contemporaines.

- Hauteur 3600 mm
- Poteau 120x64 mm
- Chevron 80x40 mm
- Gouttière 93x141 mm
- Aluminium thermolaqué Qualicoat / Qualimarine / Qualanod
- Polycarbonate translucide 10 mm traité anti UV avec obturateur alu, adhésif microperforé
- Platine de fixation au sol

COULEURS DISPONIBLES

Structure



DIMENSIONS

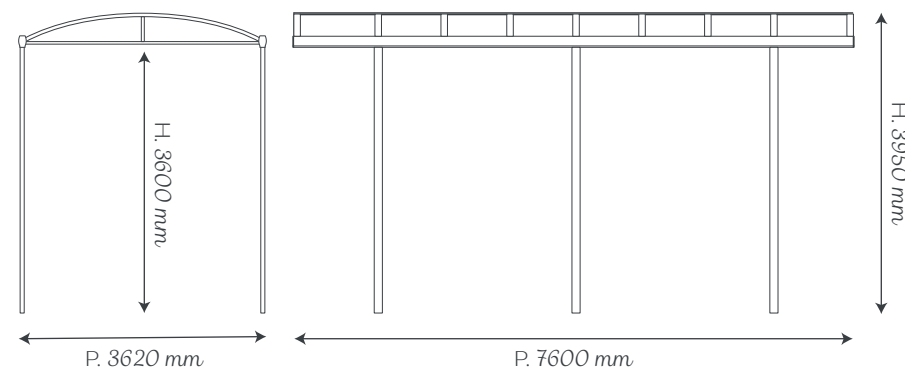

SURFACE



27,5 m²

POIDS



≈350 Kg

TOIT



Polycarbonate cintré
10mm



GARAGE&ABRI



SURFACE



13,44 m²
16,64 m²

POIDS



≈700 Kg
≈800 Kg

MUR



Mur isolé
40mm

TOIT



Toit plat isolé
30mm

CARACTÉRISTIQUES

- Abris pratique, isolé, étanche et robuste afin d'optimiser votre organisation et vos rangements, grâce à ces lignes contemporaines.
- Structure du bâti en aluminium, poteaux 100x100 mm
- Toiture en panneaux acier laqué isolé avec mousse polyuréthane haute densité 30 mm avec double renfort
- Écoulement de l'eau par les gouttières périphériques aluminium, sortie d'eau dans les angles
- Mur en panneau isolé mousse polyuréthane haute densité 40 mm avec parement gris lisse en acier laqué et nervuré blanc coté intérieure
- Porte de Garage Battant avec Hublot clair 4.8.4
- Porte de service aluminium, Serrure sept points de fermeture et deux points anti-dégel inox coté opposé

COULEURS

Extérieure



7016

Intérieure



9016

DIMENSIONS

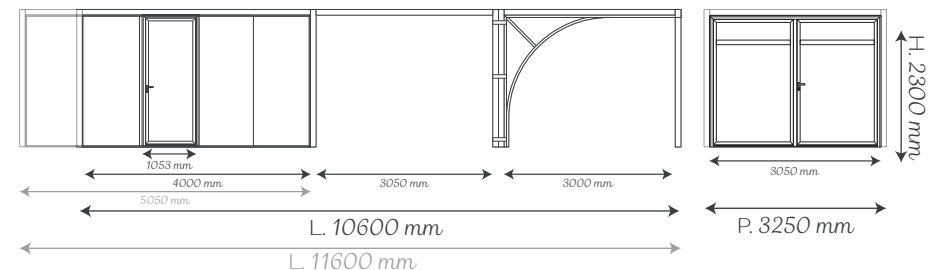

Différentes dimensions possibles :

- Réf. Garage&abri 4333 : P. 3250 x L. 10600 x H. 2300 mm
- Réf. Garage&abri 5333 : P. 3250 x L. 11600 x H. 2300 mm

OPTIONS DÉGAGEMENT



Dégagement
côté droit



Dégagement
côté gauche

CARPORT & ABRI



CARACTÉRISTIQUES

- Abris pratique, isolé, étanche et robuste afin d'optimiser votre organisation et vos rangements, grâce à ces lignes contemporaines.
- Structure du bâti en aluminium, poteaux 100x100mm
- Toiture en panneaux acier laqué isolé avec mousse polyuréthane haute densité 30 mm avec double renfort
- Écoulement de l'eau par les gouttières périphériques aluminium, sortie d'eau dans les angles
- Mur en panneau isolé mousse polyuréthane haute densité 40mm avec parement gris lisse en acier laqué et nervuré blanc coté intérieure
- Porte de Garage Battant avec Hublot clair 4.8.4
- Porte de service aluminium, Serrure sept points de fermeture et deux points anti-dégondage inox coté opposé
- Nous vous conseillons de poser systématiquement une double grille d'aération pour chaque abris

COULEURS

Extérieure



Intérieur



SURFACE



10,24 m² min.
40 m² max.

POIDS



≈540 Kg min.
≈1000 Kg max.

MUR



Mur isolé
40mm

TOIT



Toit plat isolé
30mm



DIMENSIONS

Différentes dimensions possibles :

- Réf. Carport&abri 333 : P. 3050 x L. 6400 x H. 2300 mm

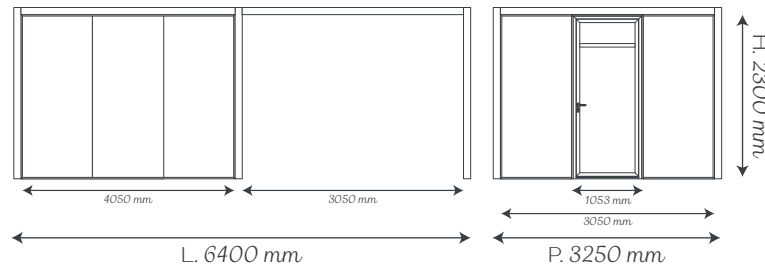

- Réf. Carport&abri 334 : P. 4250 x L. 6400 x H. 2300 mm
- Réf. Carport&abri 344 : P. 4250 x L. 7400 x H. 2300 mm

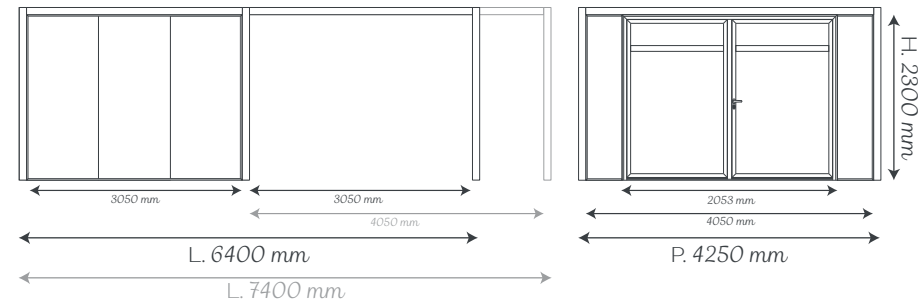

- Réf. Carport&abri 434 : P. 4250 x L. 7400 x H. 2300 mm
- Réf. Carport&abri 444 : P. 4250 x L. 8400 x H. 2300 mm

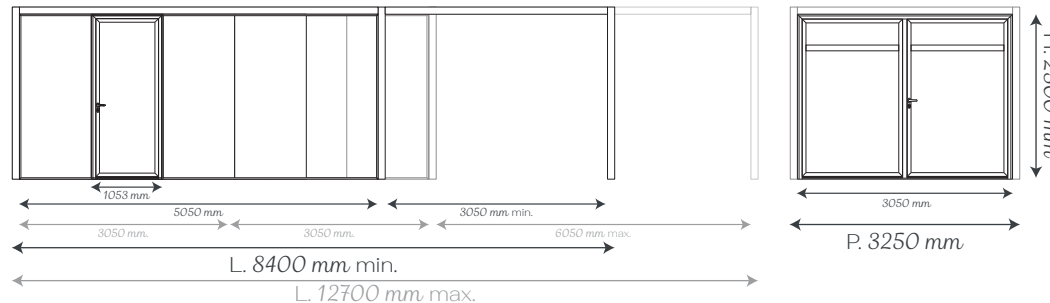
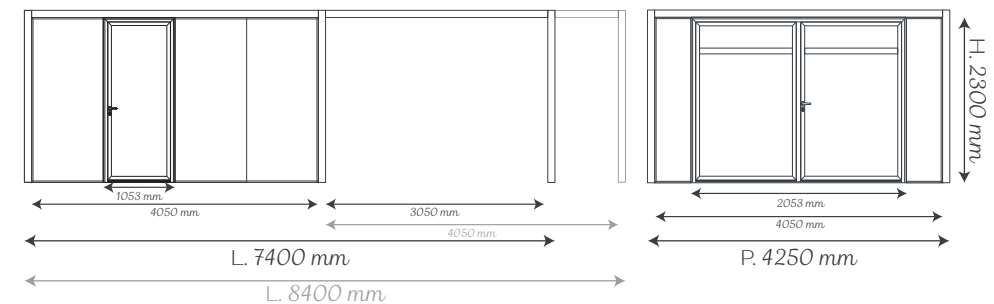

- Réf. Carport&abri 533 : P. 3250 x L. 8400 x H. 2300 mm
- Réf. Carport&abri 543 : P. 3250 x L. 9400 x H. 2300 mm
- Réf. Carport&abri 553 : P. 3250 x L. 10400 x H. 2300 mm
- Réf. Carport&abri 633 : P. 3250 x L. 9550 x H. 2300 mm
- Réf. Carport&abri 643 : P. 3250 x L. 10550 x H. 2300 mm
- Réf. Carport&abri 653 : P. 3250 x L. 11550 x H. 2300 mm
- Réf. Carport&abri 663 : P. 3250 x L. 12700 x H. 2300 mm



COFFRE DE RANGEMENT XL



CARACTÉRISTIQUES

- Abris pratique, isolé, étanche et robuste afin d'optimiser votre organisation et vos rangements, grâce à ces lignes contemporaines.
- Parois en panneau isolé mousse polyuréthane haute densité 40 mm
- Parement gris lisse en acier laqué et nervuré blanc coté intérieure
- Double vérins
- Nous vous conseillons de poser systématiquement une double grille d'aération pour chaque abris

COULEURS

Extérieure



Intérieur



DIMENSIONS

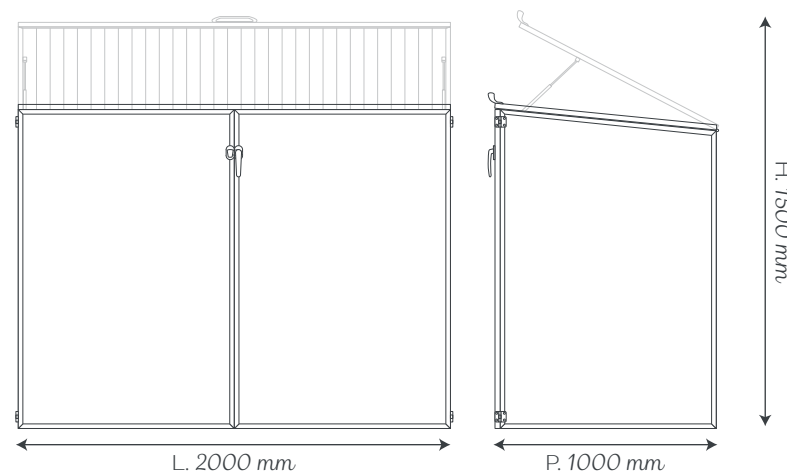

SURFACE



2 m²

POIDS



≈110 Kg

MUR



Mur isolé
40mm



PÂQUERETTE 22



CARACTÉRISTIQUES

- Abris pratique, isolé, étanche et robuste afin d'optimiser votre organisation et vos rangements, grâce à ces lignes contemporaines.
- Structure du bâti en aluminium, poteaux 100x100 mm
- Toiture en polycarbonate traité anti-uv, alvéolaire, 10 mm, clair, sur chevron en aluminium extrudé auto-drainant, section 40x40 mm, pente 10 %. Les plaques de polycarbonate sont obturées par une protection microperforée et une protection renforcée en aluminium avec un système coupe-goutte
- Mur en panneau isolé mousse polyuréthane haute densité 40 mm avec parement gris lisse en acier laqué et nervuré blanc coté intérieure
- Porte de service aluminium, serrure sept points de fermeture et deux points anti-dégondage inox coté opposé
- Nous vous conseillons de poser systématiquement une double grille d'aération pour chaque abris

COULEURS

Extérieure  7016 Intérieure  9016

DIMENSIONS

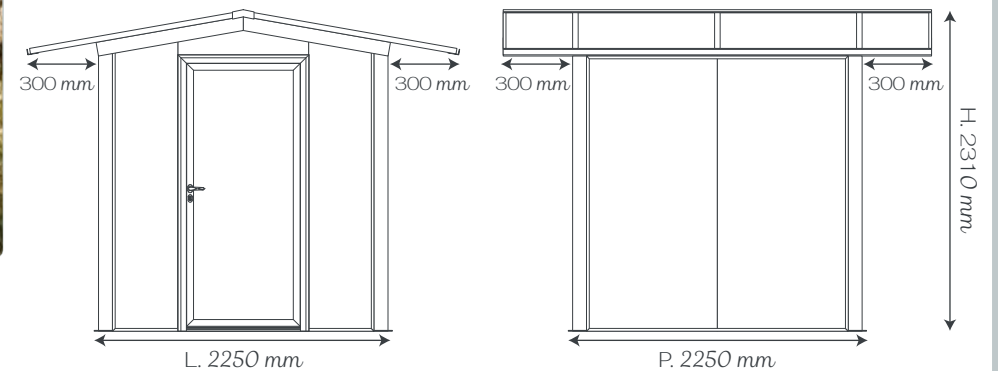

SURFACE



4,84 m²

POIDS



≈250 Kg

MUR



Mur isolé
40mm

TOIT



2 Pans Polycarbonate
10mm



ASTER 31



CARACTÉRISTIQUES

- Abris pratique, isolé, étanche et robuste afin d'optimiser votre organisation et vos rangements, grâce à ces lignes contemporaines.
- Structure du bâti en aluminium, poteaux 100x100 mm
- Toiture en polycarbonate traité anti-uv, alvéolaire, 10 mm, clair, sur chevron en aluminium extrudé auto-drainant, section 40x40 mm, pente 10 % et gouttière 93x141mm. Les plaques de polycarbonate sont obturées par une protection microperforée et une protection renforcée en aluminium avec un système coupe-goutte
- Mur en panneau isolé mousse polyuréthane haute densité 40 mm avec parement gris lisse en acier laqué et nervuré blanc côté intérieur
- Porte de service aluminium, serrure sept points de fermeture et deux points anti-dégondage inox côté opposé
- Nous vous conseillons de poser systématiquement une double grille d'aération pour chaque abris

COULEURS

Extérieure



7016

Intérieur



9016

DIMENSIONS

Réf. Aster 31^{1v}

Réf. Aster 31^{2v}

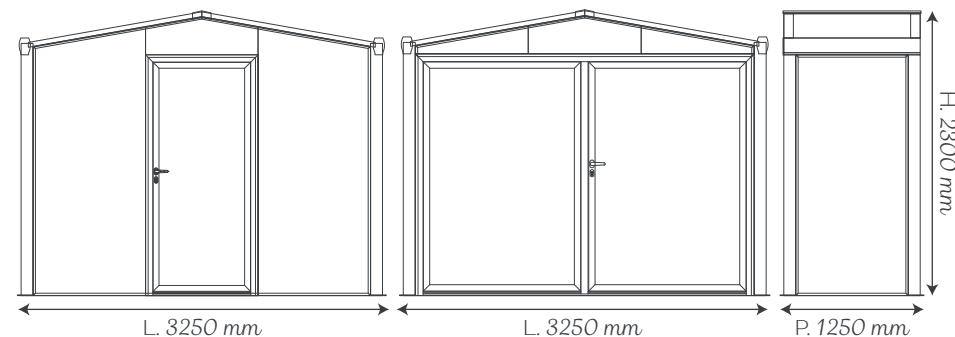

SURFACE



3,84 m²

POIDS



≈225 Kg

MUR



Mur isolé
40mm

TOIT



2 Pans Polycarbonate
10mm



ASTER 22



SURFACE



4,84 m²

POIDS



≈225 Kg

MUR



Mur isolé
40mm

TOIT



2 Pans Polycarbonate
10mm

CARACTÉRISTIQUES

- Abris pratique, isolé, étanche et robuste afin d'optimiser votre organisation et vos rangements, grâce à ces lignes contemporaines.
- Structure du bâti en aluminium, poteaux 100x100 mm
- Toiture en polycarbonate traité anti-uv, alvéolaire, 10 mm, clair, sur chevron en aluminium extrudé auto-drainant, section 40x40 mm, pente 10 % et gouttière 93x141mm. Les plaques de polycarbonate sont obturées par une protection microperforée et une protection renforcée en aluminium avec un système coupe-goutte
- Mur en panneau isolé mousse polyuréthane haute densité 40 mm avec parement gris lisse en acier laqué et nervuré blanc coté intérieur
- Porte de service aluminium, serrure sept points de fermeture et deux points anti-dégondage inox coté opposé
- Nous vous conseillons de poser systématiquement une double grille d'aération pour chaque abris

COULEURS

Extérieure



7016

Intérieure



9016

DIMENSIONS

Réf. Aster 22 1^v

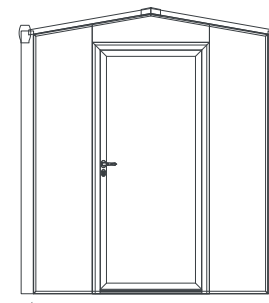

L. 2250 mm

Réf. Aster 22 2^v

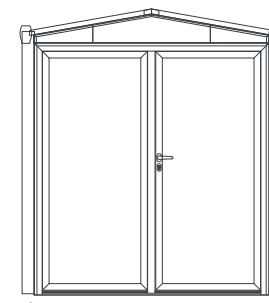

L. 2250 mm

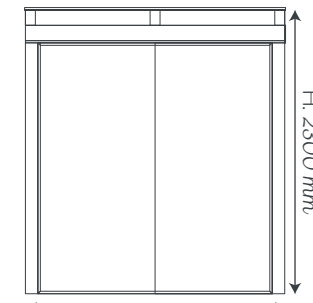

P. 2250 mm

H. 2300 mm



IRIS 31



CARACTÉRISTIQUES

- Abris pratique, isolé, étanche et robuste afin d'optimiser votre organisation et vos rangements, grâce à ces lignes contemporaines.
- Structure du bâti en aluminium, poteaux 100x100 mm
- Toiture en panneaux acier laqué isolé avec mousse polyuréthane haute densité 30 mm avec double renfort
- Écoulement de l'eau par les gouttières périphériques aluminium, sortie d'eau dans les angles
- Mur en panneau isolé mousse polyuréthane haute densité 40 mm avec parement gris lisse en acier laqué et nervuré blanc coté intérieure
- Porte de Garage Battant Lisse
- Porte de service aluminium, Serrure sept points de fermeture et deux points anti-dégondage inox coté opposé
- Nous vous conseillons de poser systématiquement une double grille d'aération pour chaque abris

COULEURS

Extérieure



7016

Intérieur



9016

DIMENSIONS

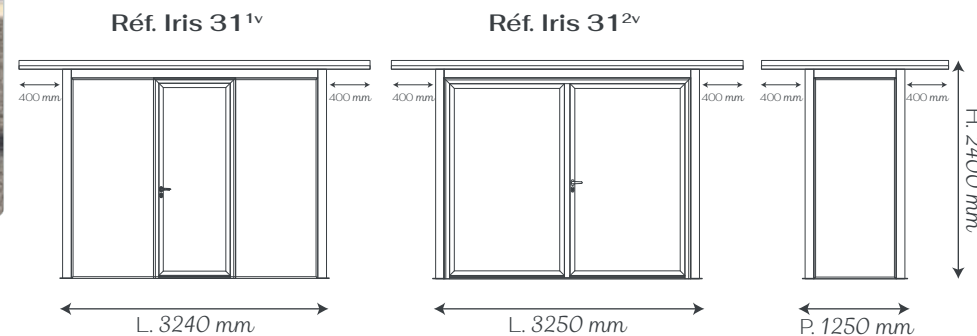

SURFACE



3,84 m²

POIDS



≈360 Kg

MUR



Mur isolé
40mm

TOIT



Toit plat isolé
30mm



IRIS 22



CARACTÉRISTIQUES

- Abris pratique, isolé, étanche et robuste afin d'optimiser votre organisation et vos rangements, grâce à ces lignes contemporaines.
- Structure du bâti en aluminium, poteaux 100x100 mm
- Toiture en panneaux acier laqué isolé avec mousse polyuréthane haute densité 30 mm avec double renfort
- Ecoulement de l'eau par les gouttières périphériques aluminium, sortie d'eau dans les angles
- Mur en panneau isolé mousse polyuréthane haute densité 40 mm avec parement gris lisse en acier laqué et nervuré blanc coté intérieure
- Porte de Garage Battant Lisse
- Porte de service aluminium, Serrure sept points de fermeture et deux points anti-dégondage inox coté opposé
- Nous vous conseillons de poser systématiquement une double grille d'aération pour chaque abris

COULEURS

Extérieure  7016 Intérieur  9016

DIMENSIONS

Réf. Iris 22 ^{1v}

Réf. Iris 22 ^{2v}

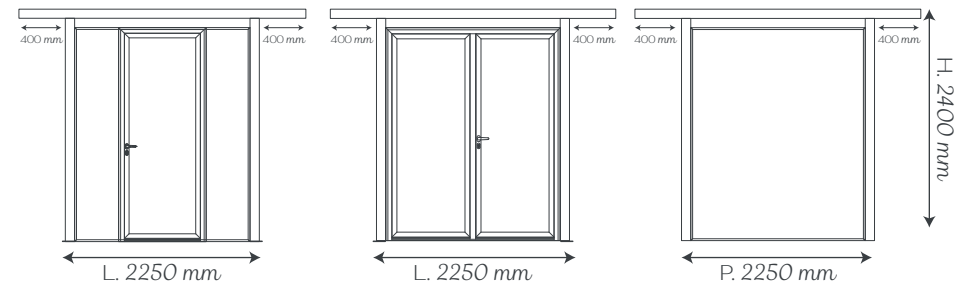

SURFACE



4,84 m²

POIDS



≈360 Kg

MUR



Mur isolé
40mm

TOIT



Toit plat isolé
30mm



ECO PORTO



CARACTÉRISTIQUES

- Abris pratique, isolé, étanche et robuste afin d'optimiser votre organisation et vos rangements, grâce à ces lignes contemporaines.
- Toiture en panneaux acier laqué isolé avec mousse polyuréthane haute densité 30mm avec double renfort
- Écoulement de l'eau par les gouttières périphériques aluminium, sortie d'eau dans les angles
- Mur en panneau isolé mousse polyuréthane haute densité 40 mm avec parement gris lisse en acier laqué et nervuré blanc côté intérieur
- Porte de Garage Battant Lisse
- Porte de service aluminium, Serrure sept points de fermeture et deux points anti-dégondage inox coté opposé
- Nous vous conseillons de poser systématiquement une double grille d'aération pour chaque abris

COULEURS

Extérieure



7016

Intérieur



9016

DIMENSIONS



SURFACE



9,67 m²

POIDS



≈ 250 Kg

MUR



Mur isolé
40mm

TOIT



Toit plat isolé
30mm





COQUELICOT

ABRIS



CARACTÉRISTIQUES

- Abris pratique, isolé, robuste afin d'optimiser votre organisation et vos rangements, grâce à ces lignes contemporaines.
- Structure du bâti en aluminium, poteaux 100x100 mm
- Toiture en polycarbonate traité anti-uv, alvéolaire, 10 mm, clair, sur chevron en aluminium extrudé auto-drainant, section 40x40 mm, pente 10 %. Les plaques de polycarbonate sont obturées par une protection microperforée et une protection renforcée en aluminium avec un système coupe-goutte
- Mur en panneau isolé mousse polyuréthane haute densité 40 mm avec parement gris lisse en acier laqué et nervuré blanc coté intérieur
- Porte de service aluminium, Serrure sept points de fermeture et deux points anti-dégondage inox coté opposé
- Nous vous conseillons de poser systématiquement une double grille d'aération pour chaque abri

COULEURS

Extérieure



Intérieur



SURFACE



7,04 m² min.
17,64 m² max.

POIDS



≈320 Kg min.
≈470 Kg max.

MUR



Mur isolé
40mm

TOIT



2 Pans Polycarbonate
10mm



DIMENSIONS

Différentes dimensions possibles :

• Réf. Coquelicot 32 : P. 2250 x L. 3250 x H. 2310 mm

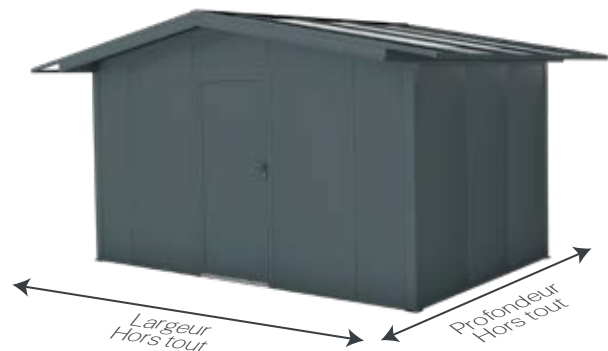
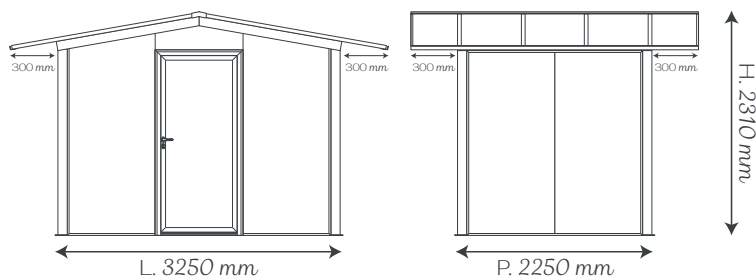

• Réf. Coquelicot 33 : P. 3250 x L. 3250 x H. 2310 mm

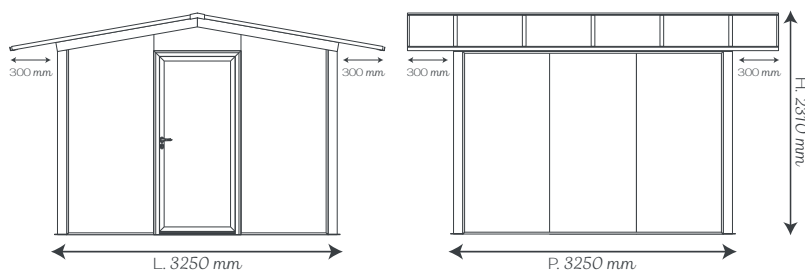

• Réf. Coquelicot 43 : P. 2250 x L. 4250 x H. 2310 mm

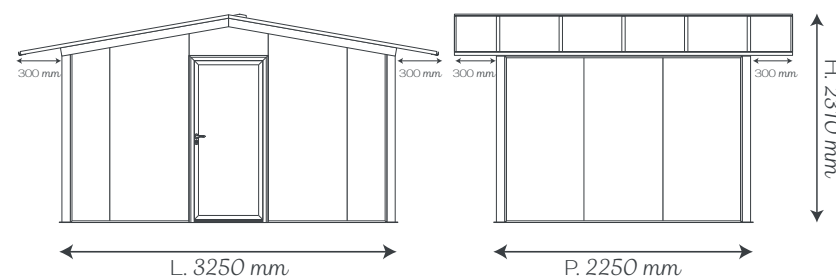

• Réf. Coquelicot 44 : P. 4250 x L. 4250 x H. 2310 mm

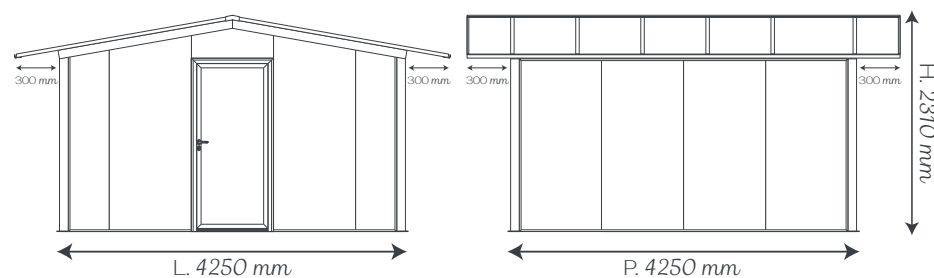



BOUTON D'OR



CARACTÉRISTIQUES

- Abris pratique, isolé, étanche et robuste afin d'optimiser votre organisation et vos rangements, grâce à ces lignes contemporaines.
- Structure du bâti en aluminium, poteaux 100x100 mm
- Toiture en polycarbonate traité anti-uv, alvéolaire, 10 mm, clair, sur chevron en aluminium extrudé auto-drainant, section 40x40 mm, pente 10 %. Les plaques de polycarbonate sont obturées par une protection microperforée et une protection renforcée en aluminium avec un système coupe-goutte
- Mur en panneau isolé mousse polyuréthane haute densité 40 mm avec parement gris lisse en acier laqué et nervuré blanc coté intérieure
- Porte de Garage Battant Lisse
- Porte de service aluminium, Serrure sept points de fermeture et deux points anti-dégondage inox coté opposé
- Nous vous conseillons de poser systématiquement une double grille d'aération pour chaque abris

COULEURS

Extérieure



Intérieure



SURFACE



10,24 m² min.
27,04 m² max.

POIDS



≈370 Kg min.
≈7470 Kg max.

MUR



Mur isolé
40mm

TOIT



2 Pans Polycarbonate
10mm



DIMENSIONS

Différentes dimensions possibles :

- Réf. Bouton d'or 33 : P. 3250 x L. 3250 x H. 2310 mm
- Réf. Bouton d'or 34 : P. 4250 x L. 3250 x H. 2310 mm

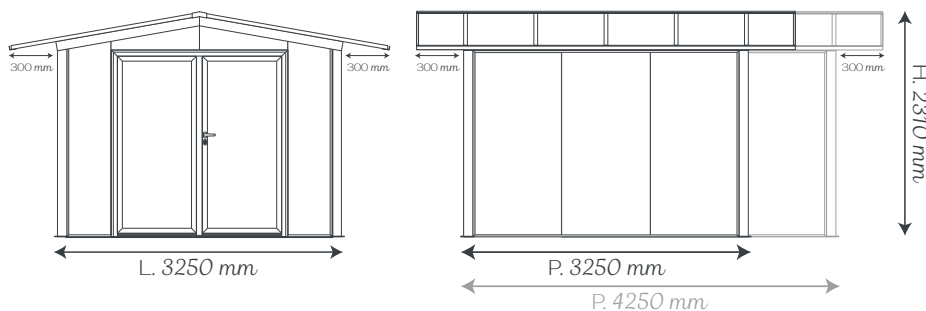

- Réf. Bouton d'or 43 : P. 3250 x L. 4250 x H. 2360 mm
- Réf. Bouton d'or 44 : P. 4250 x L. 4250 x H. 2360 mm

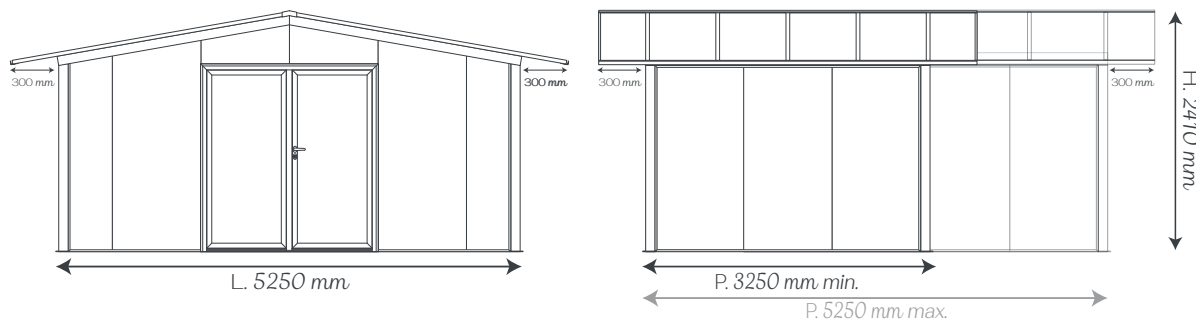
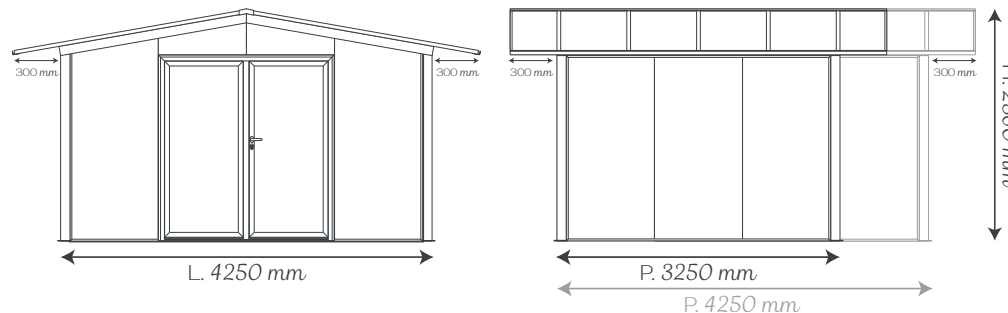

- Réf. Bouton d'or 53 : P. 3250 x L. 5250 x H. 2410 mm
- Réf. Bouton d'or 54 : P. 4250 x L. 5250 x H. 2410 mm
- Réf. Bouton d'or 55 : P. 5250 x L. 5250 x H. 2410 mm



TRÈFLE



CARACTÉRISTIQUES

- Abris pratique, isolé, étanche et robuste afin d'optimisé votre organisation et vos rangements, grâce à ces lignes contemporaines.
- Structure du bati en aluminium, poteaux 100x100 mm
- Toiture en panneaux acier laqué isolé avec mousse polyuréthane haute densité 30mm avec double renfort
- Écoulement de l'eau par les gouttières périphériques aluminium, sortie d'eau dans les angles
- Mur en panneau isolé mousse polyuréthane haute densité 40mm avec parement gris lisse en acier laqué et nervuré blanc coté intérieure
- Porte de Garage Battant Lisse
- Imposte vitrée 442.12.4, hauteur 300 mm
- Porte de service aluminium, Serrure sept points de fermeture et deux points anti-dégondage inox coté opposé
- Nous vous conseillons de poser systématiquement une double grille d'aération pour chaque abris

COULEURS

Extérieure



7016

Intérieur



9016

SURFACE



10,24 m² min.
27,04 m² max.

POIDS



≈470 Kg min.
≈670 Kg max.

MUR



Mur isolé
40mm

TOIT



Toit plat isolé
30mm



DIMENSIONS

Différentes dimensions possibles :

- Réf. Trèfle 33 : P. 3250 x L. 3250 x H. 2400 mm
- Réf. Trèfle 34 : P. 4250 x L. 3250 x H. 2400 mm

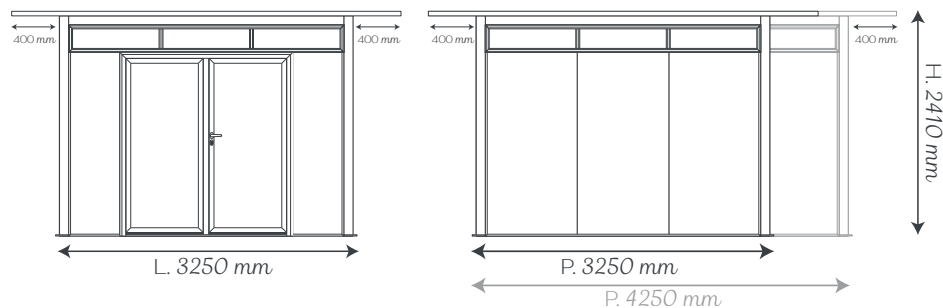

- Réf. Trèfle 43 : P. 3250 x L. 4250 x H. 2410 mm
- Réf. Trèfle 44 : P. 4250 x L. 4250 x H. 2410 mm

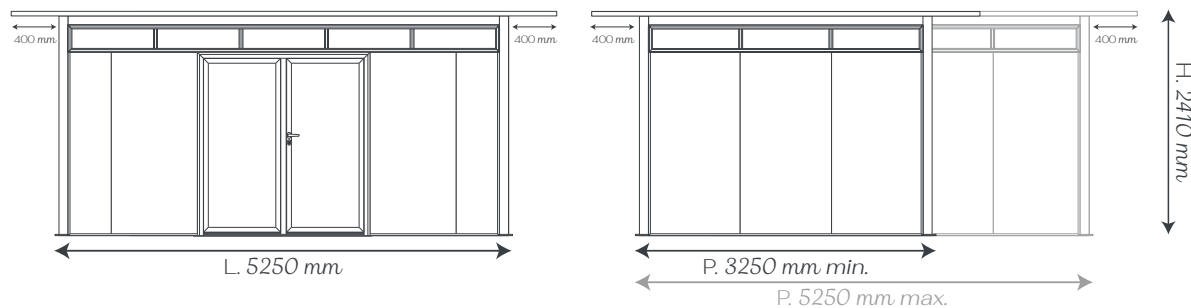
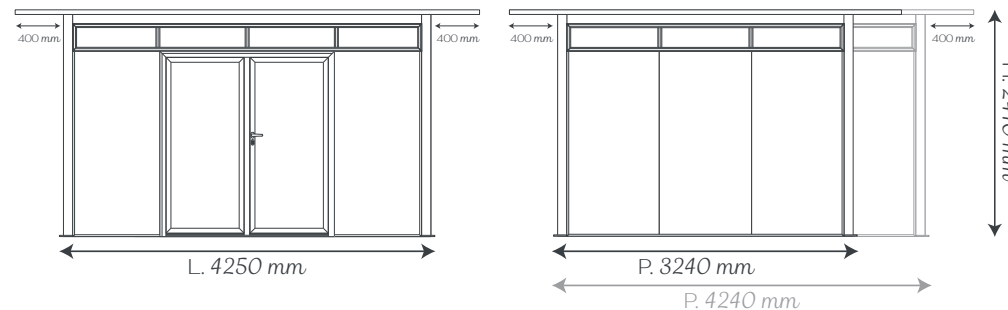

- Réf. Trèfle 53 : P. 3250 x L. 5250 x H. 2400 mm
- Réf. Trèfle 54 : P. 4250 x L. 5250 x H. 2400 mm
- Réf. Trèfle 55 : P. 5250 x L. 5250 x H. 2400 mm



MARGUERITE 33/34



CARACTÉRISTIQUES

- Abris pratique, isolé, étanche et robuste afin d'optimiser votre organisation et vos rangements, grâce à ces lignes contemporaines.
- Structure du bâti en aluminium, poteaux 100x100 mm
- Toiture en polycarbonate traité anti-uv, alvéolaire, 10 mm, clair, sur chevron en aluminium extrudé auto-drainant, section 40x40 mm, pente 10 %. Les plaques de polycarbonate sont obturées par une protection microperforée et une protection renforcée en aluminium avec un système coupe-goutte
- Mur en panneau isolé mousse polyuréthane haute densité 40 mm avec parement gris lisse en acier laqué et nervuré blanc coté intérieur
- Porte de Garage Battant Lisse
- Porte de service aluminium, Serrure sept points de fermeture et deux points anti-dégel inox coté opposé
- Nous vous conseillons de poser systématiquement une double grille d'aération pour chaque abris

COULEURS

Extérieure



7016

Intérieur



9016

DIMENSIONS

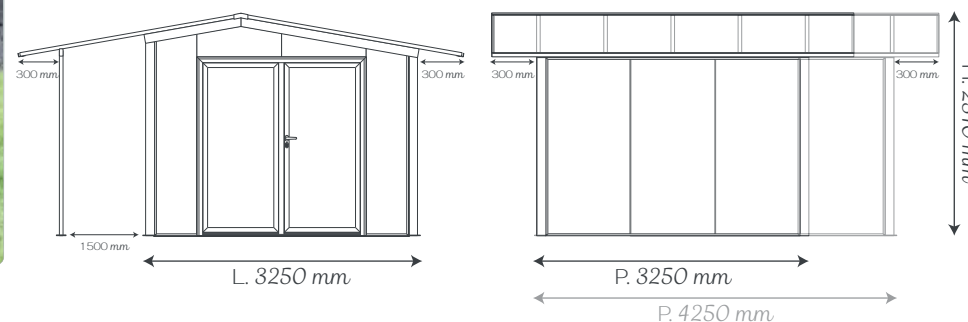

SURFACE



13,44 m²
13,44 m²

POIDS



≈470 Kg
≈470 Kg

MUR



Mur isolé
40mm

TOIT



2 Pans Polycarbonate
10mm

Différentes dimensions possibles :

- Réf. Marguerite 33 : P. 3250 x L. 3250 x H. 2310 mm
- Réf. Marguerite 34 : P. 4250 x L. 3250 x H. 2310 mm





PISSENLIT



CARACTÉRISTIQUES

- Abris pratique, isolé, étanche et robuste afin d'optimiser votre organisation et vos rangements, grâce à ces lignes contemporaines.
- Structure du bati en aluminium, poteaux 100x100 mm
- Toiture en polycarbonate traité anti-uv, alvéolaire, 10 mm, clair, sur chevron en aluminium extrudé auto-drainant, section 40x40 mm, pente 10 %. Les plaques de polycarbonate sont obturées par une protection microperforée et une protection renforcée en aluminium avec un système coupe-goutte
- Mur en panneau isolé mousse polyuréthane haute densité 40 mm avec parement gris lisse en acier laqué et nervuré blanc coté intérieure
- Porte de Garage Battant Lisse
- Deux fenêtres fixes 442.12.4, 500x1000 mm
- Porte de service aluminium, Serrure sept points de fermeture et deux points anti-dégondage inox coté opposé
- Nous vous conseillons de poser systématiquement une double grille d'aération pour chaque abris

COULEURS

Extérieure



Intérieur



SURFACE



16,64 m² min.
38,44 m² max.

POIDS



≈470 Kg min.
≈670 Kg max.

MUR



Mur isolé
40mm

TOIT



2 Pans Polycarbonate
10mm



DIMENSIONS

Différentes dimensions possibles :

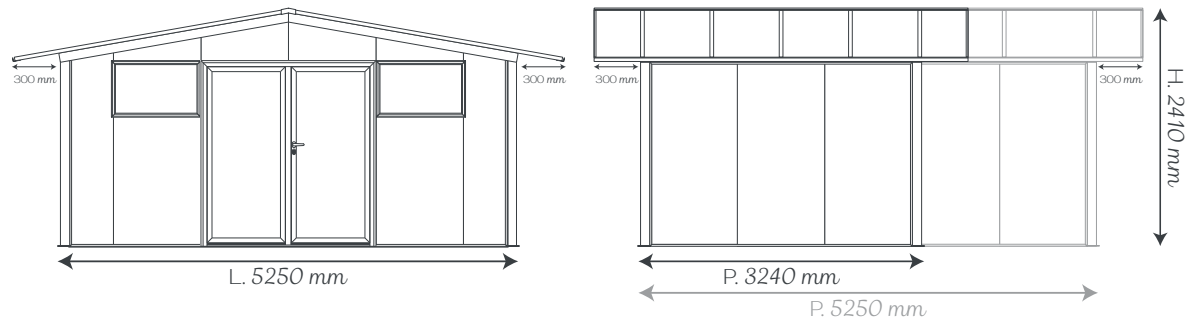

- Réf. Pissenlit 53 : P. 3250 x L. 5250 x H. 2410 mm
- Réf. Pissenlit 54 : P. 4250 x L. 5250 x H. 2410 mm
- Réf. Pissenlit 55 : P. 5250 x L. 5250 x H. 2410 mm

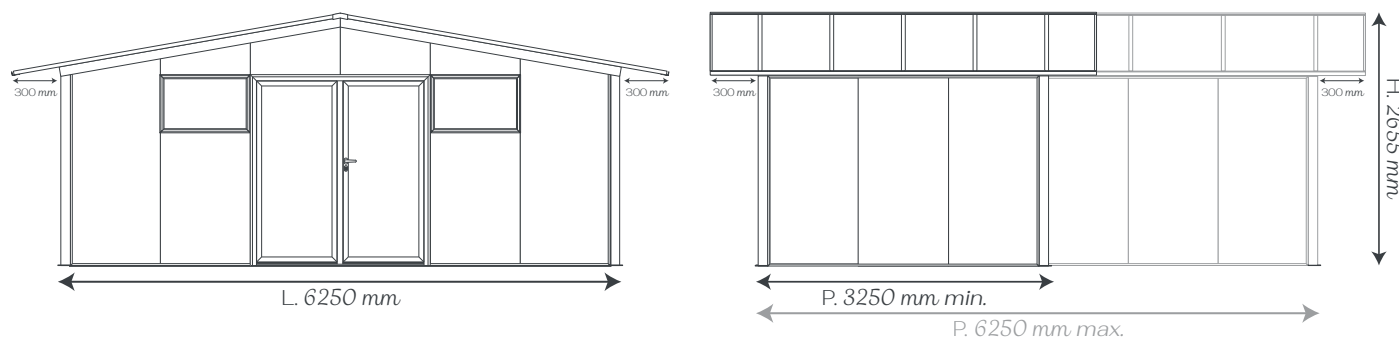
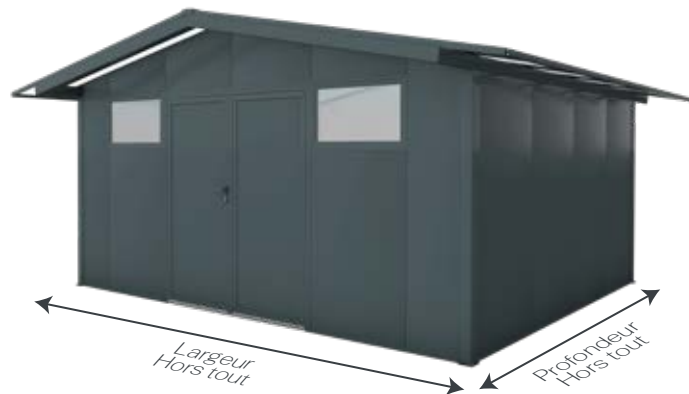

- Réf. Pissenlit 63 : P. 3250 x L. 6250 x H. 2470 mm
- Réf. Pissenlit 64 : P. 4250 x L. 6250 x H. 2470 mm
- Réf. Pissenlit 65 : P. 5250 x L. 6250 x H. 2470 mm
- Réf. Pissenlit 66 : P. 6250 x L. 6250 x H. 2470 mm



PENSÉE



CARACTÉRISTIQUES

- Abris pratique, isolé, étanche et robuste afin d'optimiser votre organisation et vos rangements, grâce à ces lignes contemporaines.
- Structure du bâti en aluminium, poteaux 100x100 mm
- Toiture en panneaux acier laqué isolé avec mousse polyuréthane haute densité 30 mm avec double renfort
- Écoulement de l'eau par les gouttières périphériques aluminium, sortie d'eau dans les angles
- Mur en panneau isolé mousse polyuréthane haute densité 40 mm avec parement gris lisse en acier laqué et nervuré blanc coté intérieure
- Porte de Garage Battant avec Hublot clair 442.12.4
- Porte de service aluminium, Serrure sept points de fermeture et deux points anti-dégondage inox coté opposé
- Nous vous conseillons de poser systématiquement une double grille d'aération pour chaque abris

COULEURS

Extérieure



Intérieure



SURFACE



13,44 m² min.
27,04 m² max.

POIDS



≈520 Kg min.
≈670 Kg max.

MUR



Mur isolé
40mm

TOIT



Toit plat isolé
30mm



DIMENSIONS

Différentes dimensions possibles :

• Réf. Pensée 43 : P. 3250 x L. 4250 x H. 2400 mm

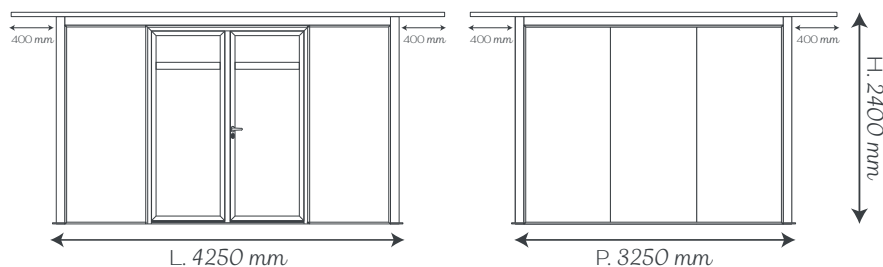

• Réf. Pensée 44 : P. 4240 x L. 4250 x H. 2400 mm

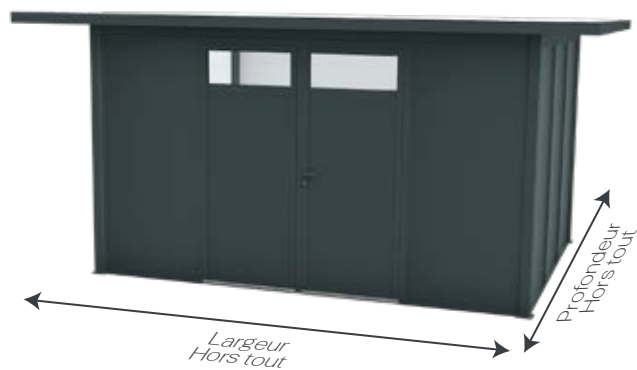
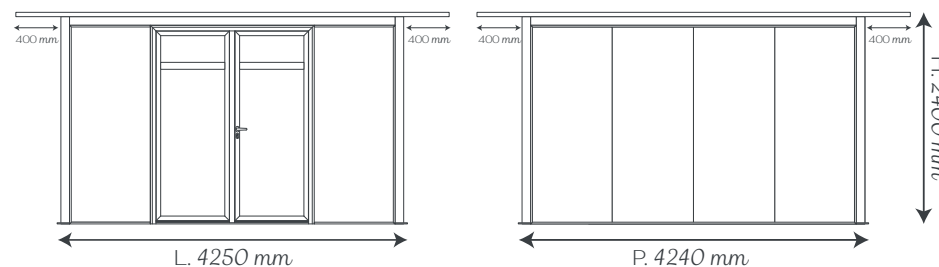

• Réf. Pensée 53 : P. 3250 x L. 5250 x H. 2400 mm

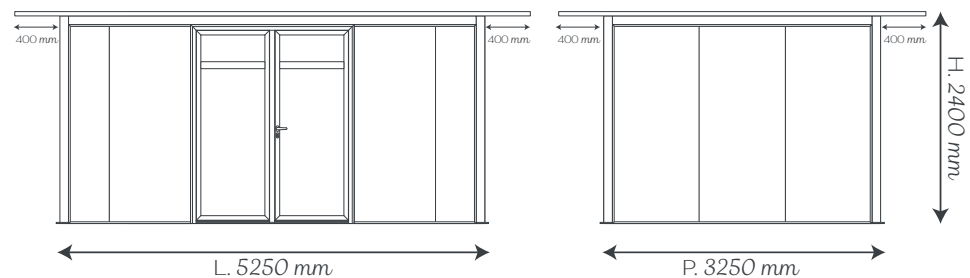

• Réf. Pensée 54 : P. 4250 x L. 5250 x H. 2400 mm

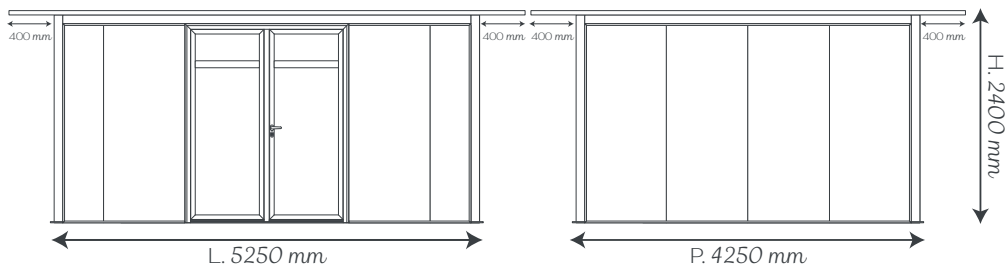

• Réf. Pensée 55 : P. 5250 x L. 5250 x H. 2400 mm

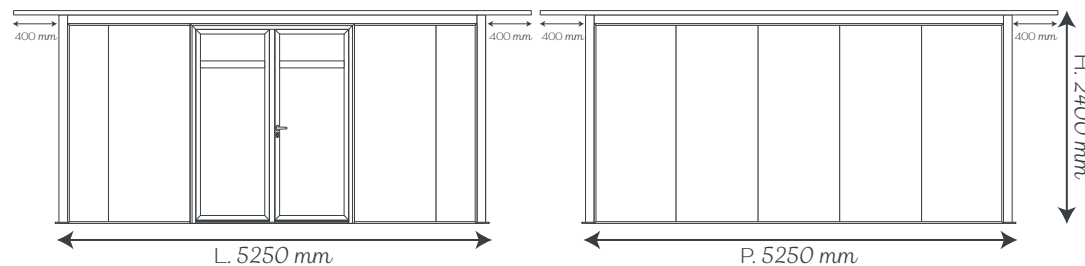



POLY-GARAGE

CARACTÉRISTIQUES

- Garage pratique, isolé, étanche et robuste afin d'optimiser votre organisation et vos rangements, grâce à ces lignes contemporaines.
- Structure du bati en aluminium, poteaux 100x100 mm
- Toiture en polycarbonate traité anti-uv, alvéolaire, 10 mm, clair, sur chevron en aluminium extrudé auto-drainant, section 40x40 mm, pente 10 %. Les plaques de polycarbonate sont obturées par une protection microperforée et une protection renforcée en aluminium avec un système coupe-goutte
- Mur en panneau isolé mousse polyuréthane haute densité 40 mm avec parement gris lisse en acier laqué et nervuré blanc coté intérieure
- Porte de Garage Battant Lisse
- Porte de service aluminium, Serrure sept points de fermeture et deux points anti-dégondage inox coté opposé
- Nous vous conseillons de poser systématiquement une double grille d'aération pour chaque abris

COULEURS

Extérieure



7016

Intérieur



9016

SURFACE



16,64 m² min.
38,44 m² max.

POIDS



≈470 Kg min.
≈670 Kg max.

MUR



Mur isolé
40mm

TOIT



2 Pans Polycarbonate
10mm



DIMENSIONS

Différentes dimensions possibles :

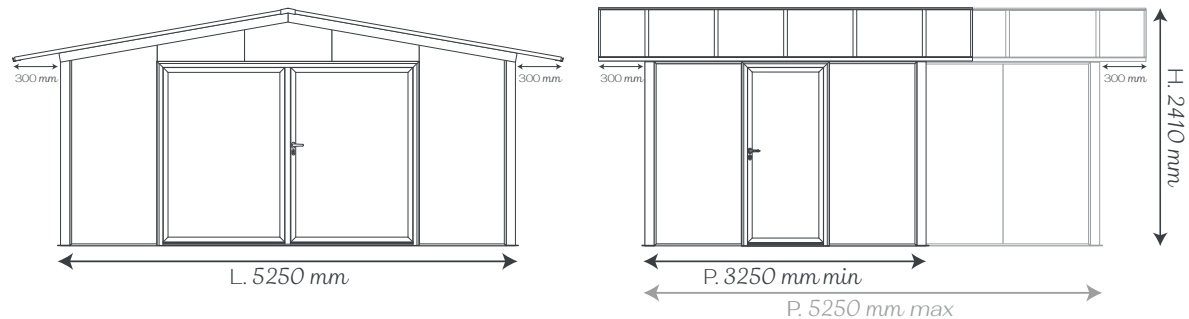

- Réf. Poly-garage 53 : P. 3250 x L. 5250 x H. 2410 mm
- Réf. Poly-garage 54 : P. 4250 x L. 5250 x H. 2410 mm
- Réf. Poly-garage 55 : P. 5250 x L. 5250 x H. 2410 mm

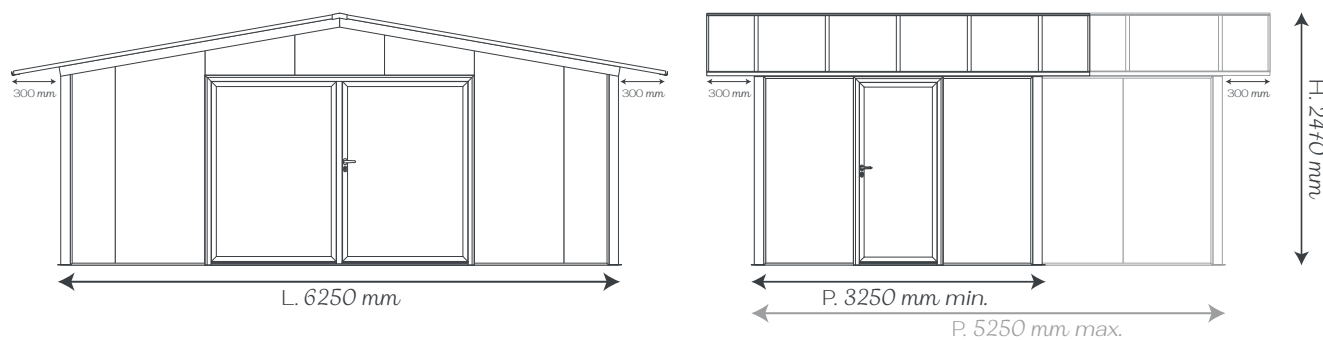
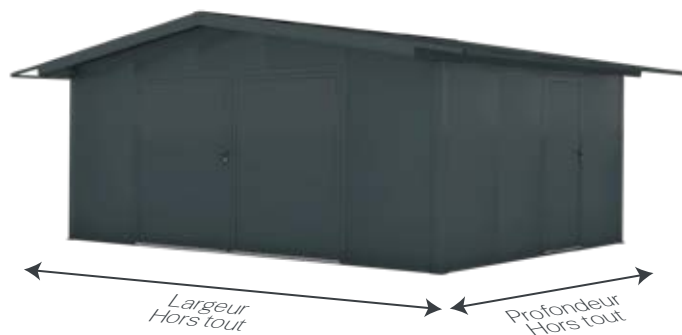

- Réf. Poly-garage 63 : P. 3250 x L. 6250 x H. 2470 mm
- Réf. Poly-garage 64 : P. 4250 x L. 6250 x H. 2470 mm
- Réf. Poly-garage 65 : P. 5250 x L. 6250 x H. 2470 mm



TOIT PLAT-GARAGE



ABRIS

CARACTÉRISTIQUES

- Garage pratique, isolé, étanche et robuste afin d'optimiser votre organisation et vos rangements, grâce à ces lignes contemporaines.
- Structure du bâti en aluminium, poteaux 100x100 mm
- Toiture en panneaux acier laqué isolé avec mousse polyuréthane haute densité 30 mm avec double renfort
- Ecoulement de l'eau par les gouttières périphériques aluminium, sortie d'eau dans les angles
- Mur en panneau isolé mousse polyuréthane haute densité 40 mm avec parement gris lisse en acier laqué et nervuré blanc coté intérieure
- Porte de garage enroulable motorisé, lame 55 mm
- Porte de service aluminium, Serrure sept points de fermeture et deux points anti-dégondage inox coté opposé
- Nous vous conseillons de poser systématiquement une double grille d'aération pour chaque abris

COULEURS

Extérieure



7016

Intérieur



9016

SURFACE



13,44 m² min.
27,04 m² max.

POIDS



≈520 Kg min.
≈670 Kg max.

MUR



Mur isolé
40mm

TOIT



Toit plat isolé
30mm



DIMENSIONS

Différentes dimensions possibles :

- Réf. Toit plat-garage 35 : P. 3250 x L. 5250 x H. 2400 mm
- Réf. Toit plat-garage 36 : P. 3250 x L. 6250 x H. 2400 mm

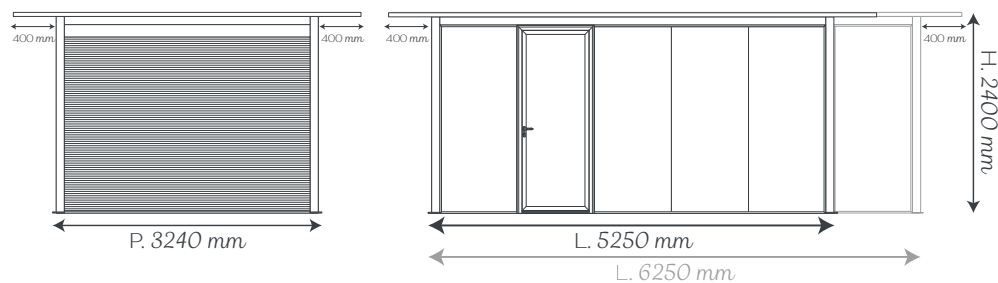

- Réf. Toit plat-garage 45 : P. 4250 x L. 5250 x H. 2400 mm
- Réf. Toit plat-garage 46 : P. 4250 x L. 6250 x H. 2400 mm

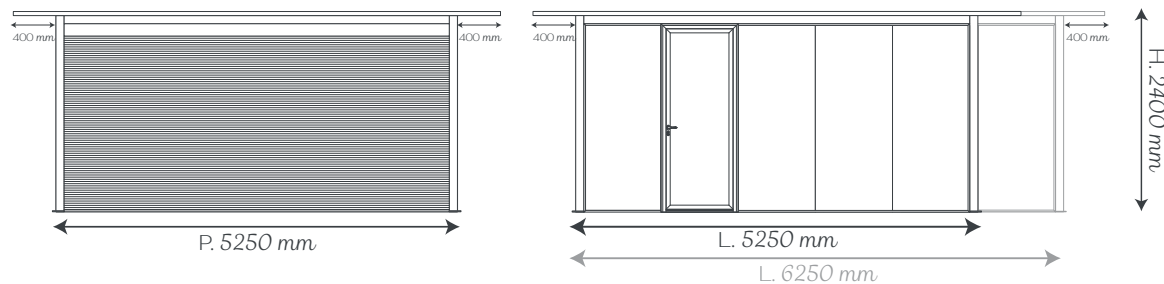
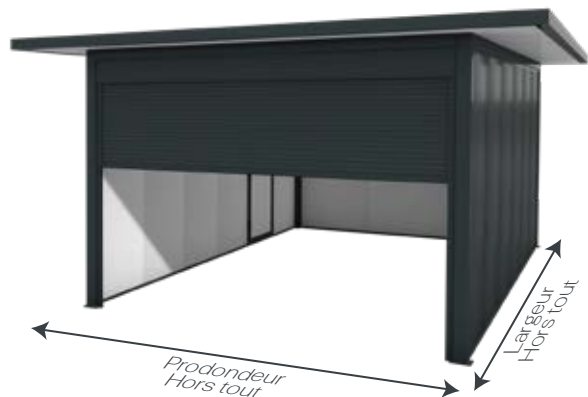
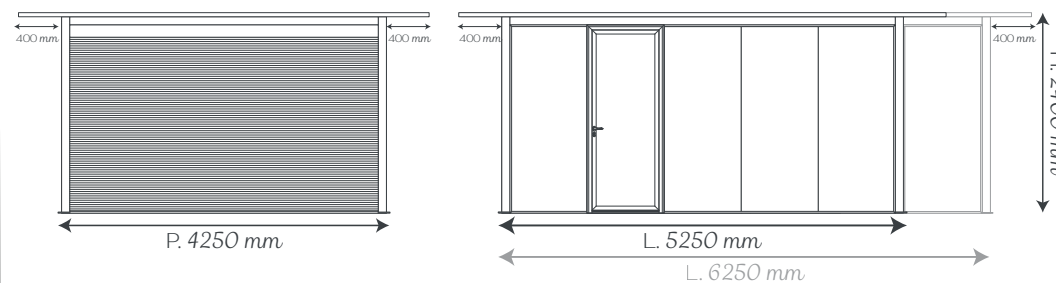

- Réf. Toit plat-garage 55 : P. 5250 x L. 5250 x H. 2400 mm
- Réf. Toit plat-garage 56 : P. 5250 x L. 6250 x H. 2400 mm



DOUBLE POLY-GARAGE



ABRIS

CARACTÉRISTIQUES

- Garage pratique, isolé, étanche et robuste afin d'optimiser votre organisation et vos rangements, grâce à ces lignes contemporaines.
- Structure du bati en aluminium, poteaux 100x100 mm
- Toiture en polycarbonate traité anti-uv, alvéolaire, 10 mm, clair, sur chevron en aluminium extrudé auto-drainant, section 40x40 mm, pente 10 %. Les plaques de polycarbonate sont obturées par une protection microperforée et une protection renforcée en aluminium avec un système coupe-goutte
- Mur en panneau isolé mousse polyuréthane haute densité 40 mm avec parement gris lisse en acier laqué et nervuré blanc coté intérieure
- Deux Portes de Garage Battant Lisses
- Porte de service aluminium, Serrure sept points de fermeture et deux points anti-dégondage inox coté opposé
- Nous vous conseillons de poser systématiquement une double grille d'aération pour chaque abris

COULEURS

Extérieure  7016 Intérieure  9016

DIMENSIONS

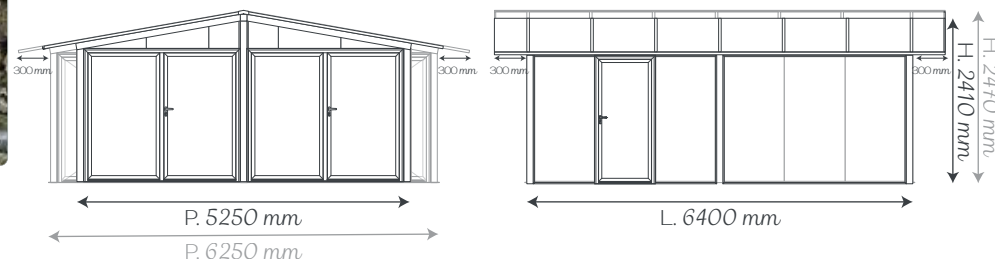

SURFACE



33,39 m²
39,69 m²

POIDS



≈750 Kg
≈800 Kg

MUR



Mur isolé
40mm

TOIT



2 Pans Polycarbonate
10mm

Différentes dimensions possibles :

- Réf. Double poly-garage 56 : P. 5250 x L. 6400 x H. 2410 mm
- Réf. Double poly-garage 66 : P. 6250 x L. 6400 x H. 2470 mm



DOUBLE TOIT PLAT-GARAGE



CARACTÉRISTIQUES

- Garage pratique, isolé, étanche et robuste afin d'optimiser votre organisation et vos rangements, grâce à ces lignes contemporaines,.
- Structure du bâti en aluminium, poteaux 100x100 mm
- Toiture en panneaux acier laqué isolé avec mousse polyuréthane haute densité 30mm avec double renfort
- Écoulement de l'eau par les gouttières périphériques aluminium, sortie d'eau dans les angles
- Mur en panneau isolé mousse polyuréthane haute densité 40 mm avec parement gris lisse en acier laqué et nervuré blanc coté intérieure
- Deux portes de Garage Battant avec Hublot 442.12.4
- Porte de service aluminium, Serrure sept points de fermeture et deux points anti-dégondage inox coté opposé

COULEURS

Extérieure



7016

Intérieure



9016

DIMENSIONS

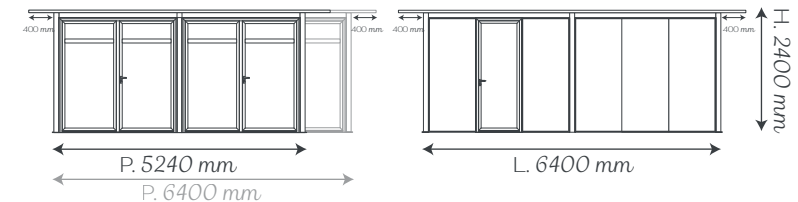

Différentes dimensions possibles :

- Réf. Double toit plat-garage 56 : P. 5250 x L. 6400 x H. 2400 mm
- Réf. Double toit plat-garage 66 : P. 6400 x L. 6400 x H. 2400 mm

SURFACE



33,39 m²
39,69 m²

POIDS



≈750 Kg
≈800 Kg

MUR



Mur isolé
40mm

TOIT



Toit plat isolé
30mm



CAMOMILLE



ABRIS

CARACTÉRISTIQUES

- Abris pratique, isolé, étanche et robuste afin d'optimiser votre organisation et vos rangements, grâce à ces lignes contemporaines.
- Structure du bati en aluminium, poteaux 100x100 mm
- Toiture en panneaux acier laqué isolé avec mousse polyuréthane haute densité 30 mm avec double renfort
- Écoulement de l'eau par les gouttières périphériques aluminium, sortie d'eau dans les angles
- Mur en panneau isolé mousse polyuréthane haute densité 40 mm avec parement gris lisse en acier laqué et nervuré blanc coté intérieure
- Porte de Garage Battant avec Hublot 442.12.4
- Porte de service aluminium, Serrure sept points de fermeture et deux points anti-dégondage inox coté opposé
- Nous vous conseillons de poser systématiquement une double grille d'aération pour chaque abris

COULEURS

Extérieure



7016

Intérieur



9016

SURFACE

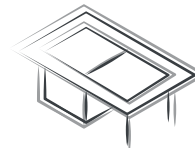

30,66 m² min.
58,76 m² max.

POIDS



≈720 Kg min.
≈970 Kg max.

MUR



Mur isolé
40mm

TOIT



Toit plat isolé
30mm



DIMENSIONS

Différentes dimensions possibles :

- Réf. Camomille 333 : P. 3250 x L. 6400 x H. 2400 mm
- Réf. Camomille 334 : P. 4250 x L. 6400 x H. 2400 mm

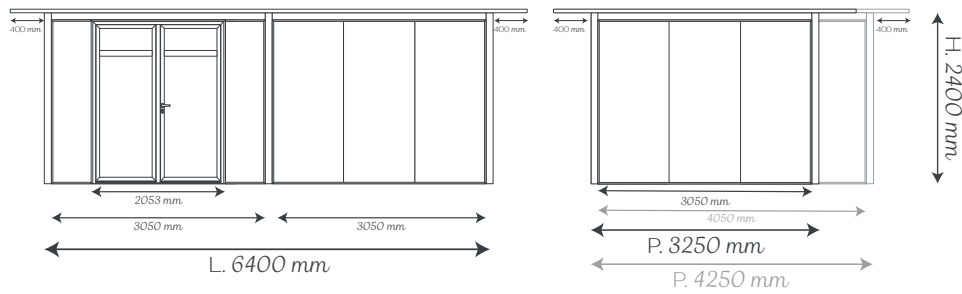

- Réf. Camomille 443 : P. 3250 x L. 8400 x H. 2400 mm
- Réf. Camomille 444 : P. 4250 x L. 8400 x H. 2400 mm

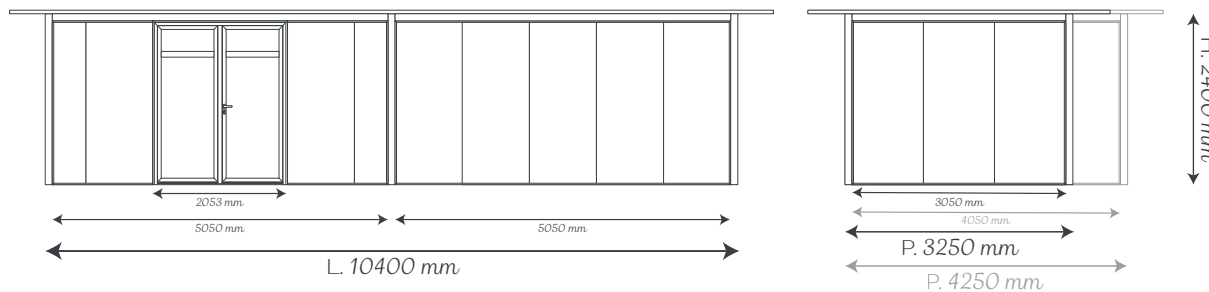
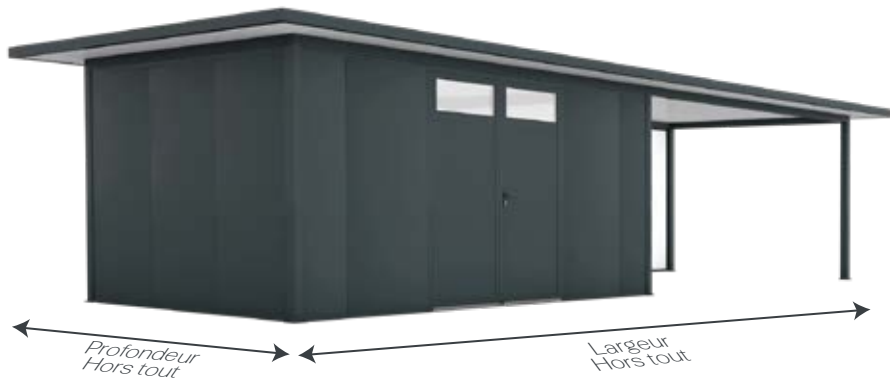
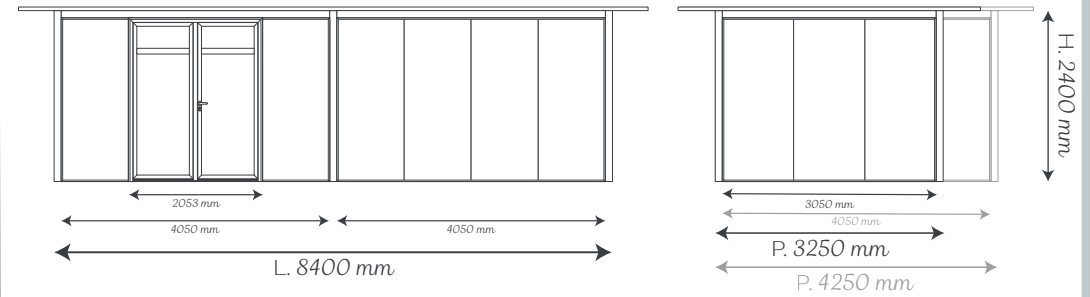

- Réf. Camomille 553 : P. 3250 x L. 10400 x H. 2400 mm
- Réf. Camomille 554 : P. 4250 x L. 10400 x H. 2400 mm



COFFRE DE RANGEMENT XL



CARACTÉRISTIQUES

- Abris pratique, isolé, étanche et robuste afin d'optimiser votre organisation et vos rangements, grâce à ces lignes contemporaines.
- Parois en panneau isolé mousse polyuréthane haute densité 40 mm
- Parement gris lisse en acier laqué et nervuré blanc coté intérieure
- Double vérins
- Nous vous conseillons de poser systématiquement une double grille d'aération pour chaque abris

COULEURS

Extérieure



7016

Intérieure



9016

DIMENSIONS

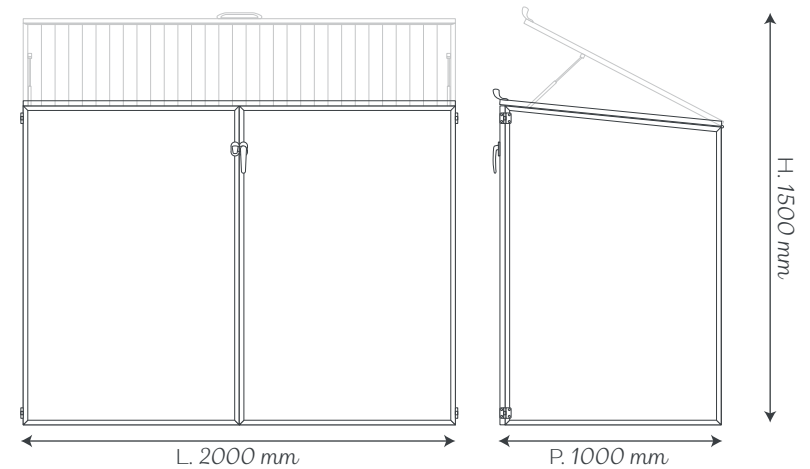

SURFACE



2 m²

POIDS



≈110 Kg

MUR



Mur isolé
40mm





MOBILIER DE JARDIN



72 MOBILIER CUISINE EXTÉRIEUR



Caisson



Caisson bas



*Caisson
Évier et robinet*



*Caisson
Angle de jonction*



*Caisson
Cave à vin*



Joue latéral
Options



Crédence
Options



Étagères
Options



*Support
ustensiles*
Options

74 TABLES



74
Maestro
Table plateau aluminium



75
Gran Gusto
Table plateau céramique



76
Bela Artisanato
Table plateau
céramique



77
Grande Artisanato
Table plateau
céramique



78
Maestria
Table extensible
aluminium



79
Majestuoso
Table extensible
aluminium/céramique



80
Viva la vida
Table basse
aluminium



81
Viva la bodega
Table basse
aluminium/céramique





MOBILIER DE JARDIN



82 CHAISES



82

Conforto

Fauteuil aluminium textilène



83

Robusto

Fauteuil aluminium textilène

84 BAINS DE SOLEIL



84

Madeira

Bain de soleil aluminium



85

Acores

Bain de soleil aluminium



85

Acores

Desserte pour bain de soleil

86 SALON DE JARDIN



86

Sofa - Poltrona - Table bela sofa

3 places - 1 place

88 MOBILIER DE RANGEMENT



88

Bric à brac M

Coffre de rangement



89

Bric à brac L

Coffre de rangement



90

Coffre de rangement XL

92 CHAUFFAGE DE TERRASSE



92

Pequeno et Bonito

Chauffage de terrasse à pellet



93

Medio et Bonito

Chauffage de terrasse à pellet



94

Grandissimo et bonito

Chauffage de terrasse à pellet





CAISSONS DE CUISINE

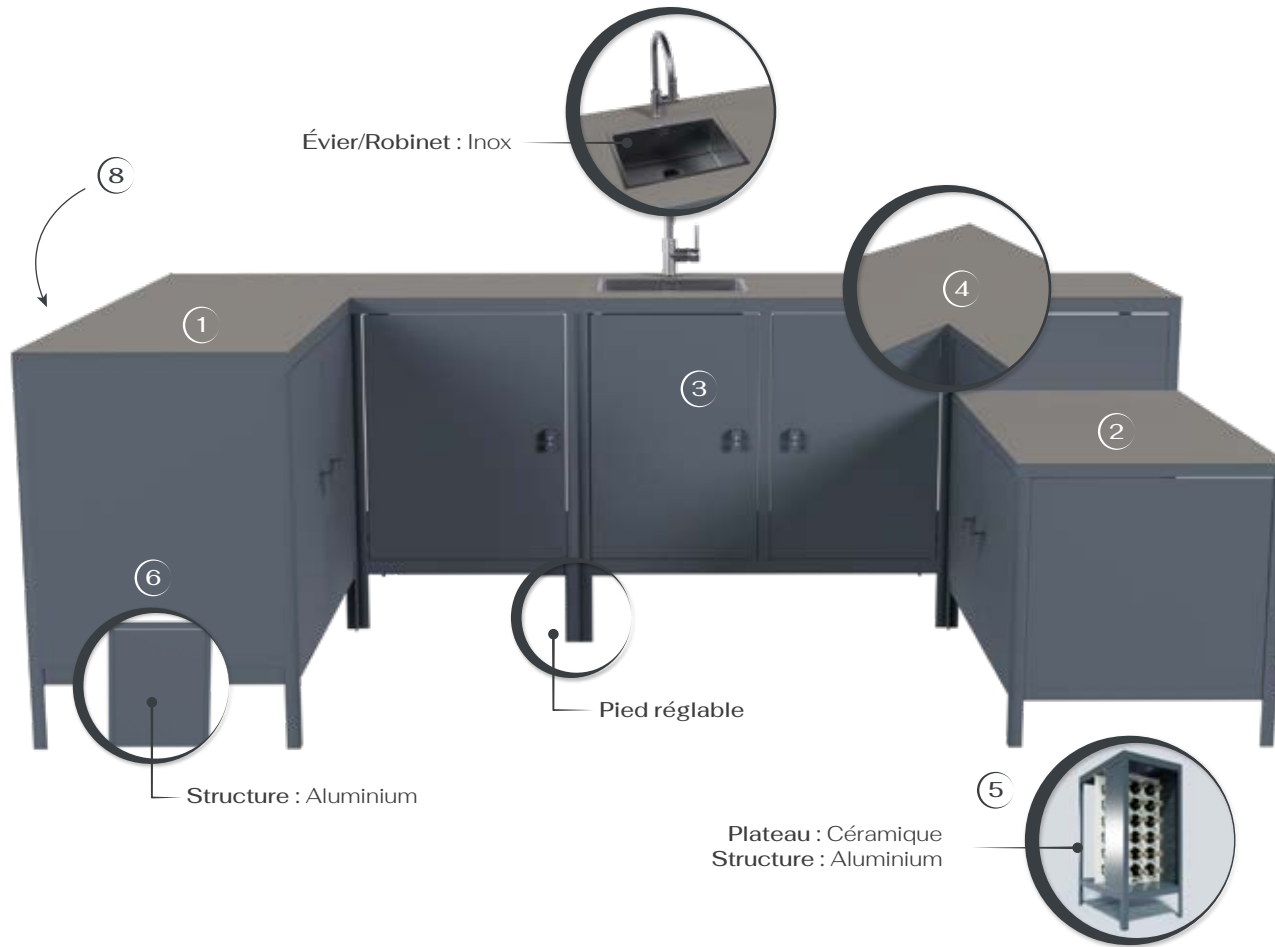

CARACTÉRISTIQUES

• Caissons de cuisine modulables d'extérieur en aluminium et plateau céramique

1. Réf. Caisson :

- L. 600 x P. 600 x H. 900 mm (1 porte)
- L. 1000 x P. 600 x H. 900 mm (2 portes)
- L. 1400 x P. 600 x H. 900 mm (3 portes)

2. Réf. Caisson bas (spécial plancha) :

- L. 1000 x P. 600 x H. 650 mm (2 portes)
- L. 1400 x P. 600 x H. 650 mm (3 portes)

3. Réf. Caisson évier et robinet :

- L. 600 x P. 600 x H. 900 mm
- L. 1000 x P. 600 x H. 900 mm
- L. 1400 x P. 600 x H. 900 mm

4. Réf. Caisson angle de jonction :

- L. 600 x P. 600 x H. 900 mm

5. Réf. Caisson cave à vin :

- L. 400 x P. 600 x H. 900 mm

6. Réf. Joue latéral

7. Réf. Crédence

8. Réf. Fond caisson

OPTIONS

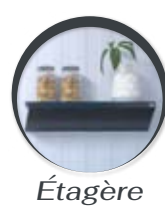
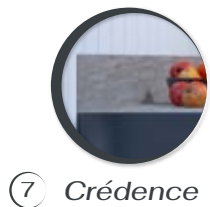

COULEURS DISPONIBLES

Structure	9016 Sablé	7016 Sablé	7036 Métallique texturé	1019 Métallique texturé	2100 Métallique texturé
Plateau	Travestino gris	Emperador noir	Forêt nuit	Forêt acier	Forêt rovere
	Subway 1	Subway 2			

MAESTRO | Table plateau en aluminium



CARACTÉRISTIQUES

- Structure en aluminium 60x60
- Table fixe rectangulaire
- Plateau en aluminium
- Fraisage 200 mm
- Aluminium thermolaqué Qualicoat / Qualimarine / Qualanod
- A monter soi-même

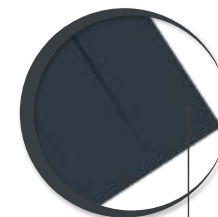

Plateau : Aluminium
Structure : Aluminium

COULEURS DISPONIBLES



DIMENSIONS



Différentes dimensions possibles :

L. 1200 x P. 1200 x H. 760 mm

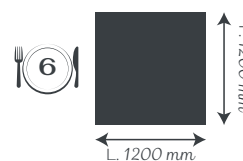

L. 2400 x P. 1000 x H. 760 mm

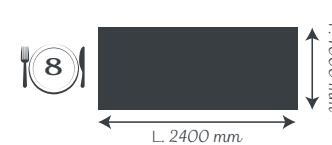

L. 1400 x P. 1400 x H. 760 mm

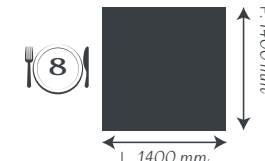



GRAN GUSTO | Table plateau céramique



CARACTÉRISTIQUES

- Structure en aluminium 100x100
- Table fixe rectangulaire
- Plateau en céramique
- Aluminium thermolaqué Qualicoat / Qualimarine / Qualanod
- A monter soi-même

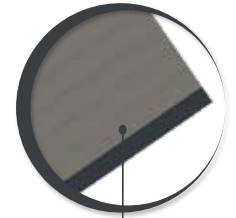

Plateau : Céramique
Structure : Aluminium

COULEURS DISPONIBLES

Structure



9016
Blanc



7016
Gris anthracite



7036
Gris Métallique



1019
Sablé Métallique



2100
Noir

Plateau



Travestino
gris



Emperador
noir



Forêt nuit



Forêt acier



Forêt rovere



Subway 1



Subway 2

DIMENSIONS

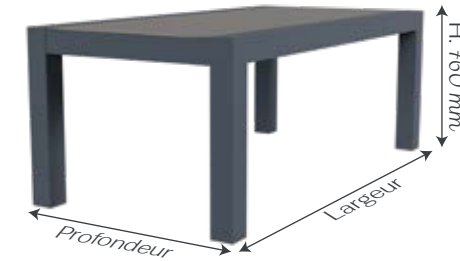

Différentes dimensions possibles :

L. 2000 x P. 1200 x H. 760 mm

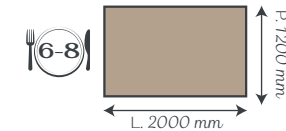

L. 2400 x P. 1200 x H. 760 mm

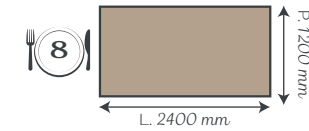

L. 2400 x P. 1200 x H. 760 mm

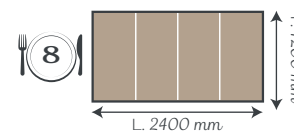

Lame céramique de 600 mm
4 perpendiculaires structure

L. 1400 x P. 1400 x H. 760 mm

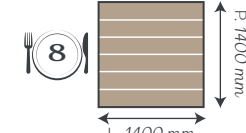

Lame céramique de 200 mm
6 parallèles structure

L. 1200 x P. 1200 x H. 760 mm

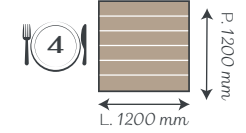

Lame céramique de 200 mm
6 parallèles structure

BELA ARTISANATO | Table plateau en céramique



CARACTÉRISTIQUES

- Structure en aluminium 60x60
- Table fixe rectangulaire
- Plateau en céramique surface intérieur
- Aluminium thermolaqué Qualicoat / Qualimarine / Qualanod
- A monter soi-même

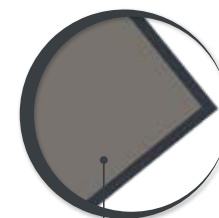

Plateau : Céramique
Structure : Aluminium

COULEURS DISPONIBLES

Structure



Plateau



DIMENSIONS

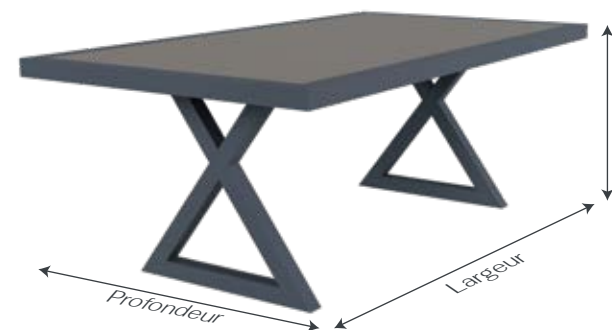

OPTIONS PIEDS



Différentes dimensions possibles :

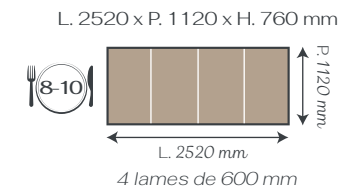
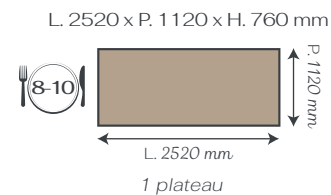
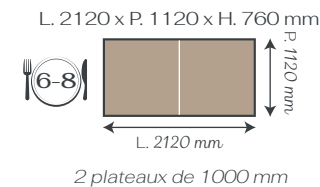
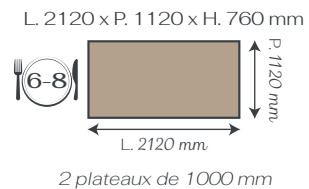



GRANDE ARTISANATO | Table plateau céramique



CARACTÉRISTIQUES

- Structure en aluminium 60x60
- Table fixe rectangulaire
- Plateau en céramique surface totale
- Aluminium thermolaqué Qualicoat / Qualimarine / Qualanod
- A monter soi-même



Plateau : Céramique
Structure : Aluminium

COULEURS DISPONIBLES

Structure



9016
Blanc



7016
Gris anthracite



7036
Gris Métallique



1019
Sablé Métallique



2100
Noir

Plateau



Travertino
gris



Emperador
noir



Forêt nuit



Forêt acier



Forêt rovere



Subway 1



Subway 2

DIMENSIONS

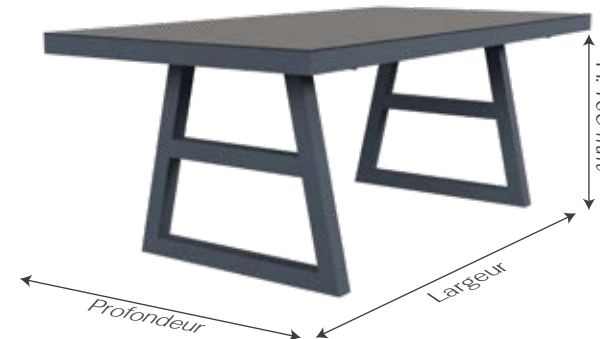

OPTIONS PIEDS



Pieds en X



Pieds en A



Pieds en U

Différentes dimensions possibles :

L. 2000 x P. 1000 x H. 760 mm

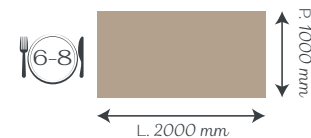

L. 2400 x P. 1000 x H. 760 mm

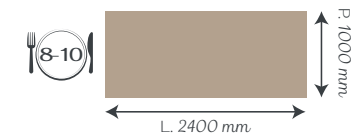

MAESTRIA | Table extensible en aluminium



CARACTÉRISTIQUES

- Structure en aluminium 70x70
- Table extensible rectangulaire
- Plateau en aluminium
- Rallonge : élévation manuelle assistée
- Aluminium thermolaqué Qualicoat / Qualimarine / Qualanod
- A monter soi-même



Plateau : Aluminium
Structure : Aluminium

COULEURS DISPONIBLES



DIMENSIONS

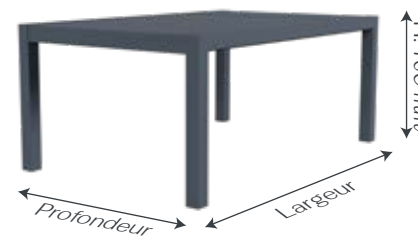

Différentes dimensions possibles :

P. 1145 x L. 1800/2700 x H. 760 mm

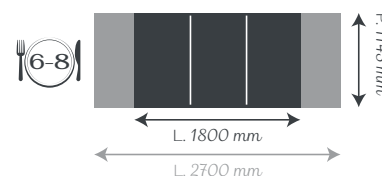

3 plateaux de 900 mm

P. 1000 x P. 2200/3300 x H. 760 mm

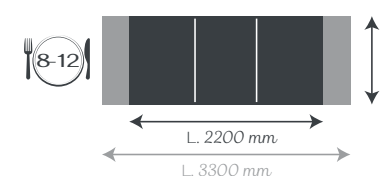

3 plateaux de 1100 mm



MAJESTUOSO | Table extensible aluminium/céramique



CARACTÉRISTIQUES

- Structure en aluminium 70x70
- Table extensible rectangulaire
- Plateau en céramique
- Rallonge : élévation manuelle assistée
- Aluminium thermolaqué Qualicoat / Qualimarine / Qualanod
- A monter soi-même

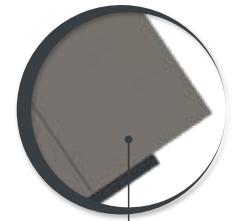

Plateau : Céramique
Structure : Aluminium

COULEURS DISPONIBLES

Structure



9016
Blanc



7016
Gris anthracite



7036
Gris Métallique



1019
Sablé Métallique



2100
Noir

Plateau



Travestino
gris



Emperador
noir



Forêt nuit



Forêt acier



Forêt rovere



Subway 1



Subway 2

DIMENSIONS

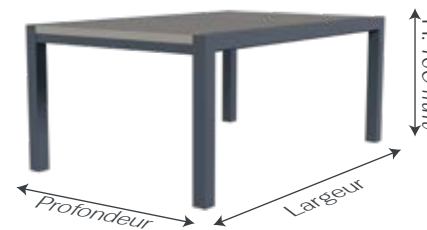

Différentes dimensions possibles :

P. 1145 x L. 1800/2700 x H. 760 mm

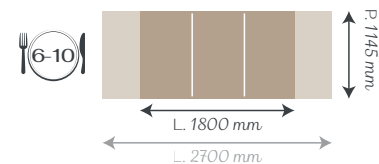

3 plateaux de 900 mm

P. 1145 x P. 2200/3400 x H. 760 mm

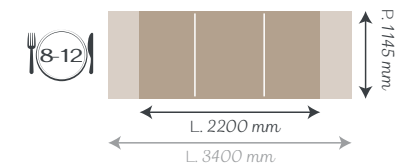

2 plateaux de 1100 mm
1 plateau de 1240 mm

VIVA LA VIDA | Table basse en aluminium



CARACTÉRISTIQUES

- Structure en aluminium 60x60
- Table basse fixe rectangulaire
- Plateau en aluminium
- Aluminium thermolaqué Qualicoat / Qualimarine / Qualanod

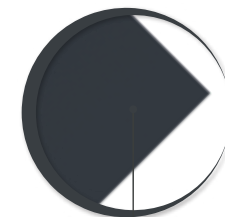

Plateau : Aluminium
Structure : Aluminium

COULEURS DISPONIBLES



DIMENSIONS

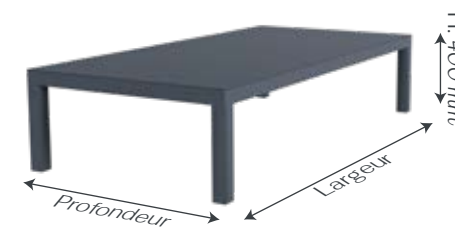

Différentes dimensions possibles :

L. 1250 x P. 900 x H. 400 mm

L. 900 x P. 900 x H. 400 mm

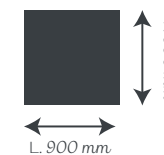
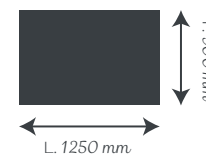



VIVA LA BODEGA | Table basse aluminium céramique



CARACTÉRISTIQUES

- Structure en aluminium 60x60 et 100x100
- Table basse fixe rectangulaire
- Plateau en céramique surface totale et intérieur
- Aluminium thermolaqué Qualicoat / Qualimarine / Qualanod

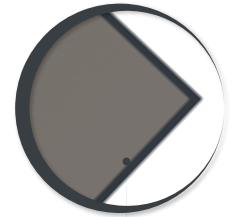

Surface : Céramique
Périmètre : Aluminium
Structure : Aluminium

COULEURS DISPONIBLES

Structure



9016
Blanc



7016
Gris anthracite



7036
Gris Métallique



1019
Sablé Métallique



2100
Noir

Plateau



Travestino
gris



Emperador
noir



Forêt nuit



Forêt acier



Forêt rovere



Subway 1



Subway 2

DIMENSIONS

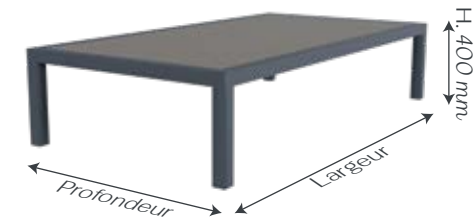

Différentes dimensions possibles :

L. 1020 x P. 1120 x H. 400 mm

L. 1000 x P. 1200 x H. 400 mm

L. 1000 x P. 1000 x H. 400 mm

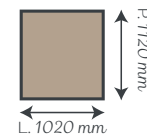

L. 1020 mm

P. 1120 mm

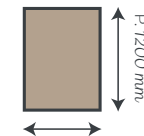

L. 1000 mm

P. 1200 mm

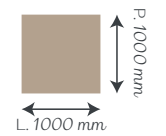

L. 1000 mm

P. 1000 mm

Céramique surface intérieur
Structure 60x60

Céramique surface intérieur
Structure 100x100

Céramique surface intérieur
Structure 60x60



CONFORTO | Fauteuil en aluminium textilène



CARACTÉRISTIQUES

- Fauteuil empilable en aluminium et textilène
- Aluminium thermolaqué Qualicoat / Qualimarine / Qualanod

COULEURS DISPONIBLES

<i>Structure</i>	 9016 Blanc	 7016 Gris anthracite	 7036 Gris Métallique	 1019 Sablé Métallique	 2100 Noir	
<i>Toile</i>	 Sable blanc	 Peau	 Luxure blanche	 Gris	 Moka	 Ébène

DIMENSIONS

L. 560 x P. 570 x H. 850 mm

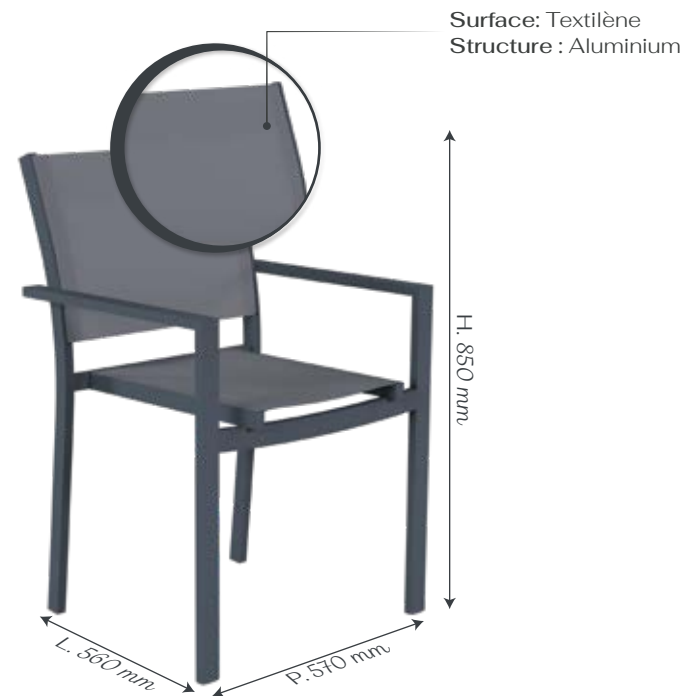



ROBUSTO | Fauteuil en aluminium textilène



CARACTÉRISTIQUES

- Fauteuil empilable en aluminium et textilène
- Aluminium thermolaqué Qualicoat / Qualimarine / Qualanod

COULEURS DISPONIBLES

Structure



9016
Blanc



7016
Gris anthracite



7036
Gris Métallique



1019
Sablé Métallique



2100
Noir

Toile



Sable
blanc



Peau



Luxure
blanche



Gris



Moka



Ébène

DIMENSIONS

L. 560 x P. 570 x H. 850 mm

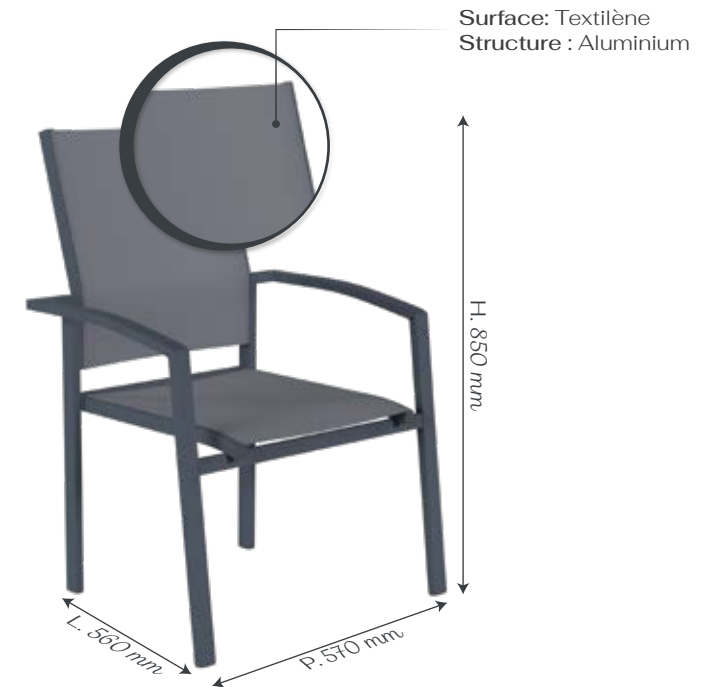



MADEIRA | Bain de soleil en aluminium textilène



CARACTÉRISTIQUES

- Bain de soleil en aluminium et textilène
- Aluminium thermolaqué Qualicoat / Qualimarine / Qualanod

COULEURS DISPONIBLES

Structure



9016
Blanc



7016
Gris anthracite



7036
Gris Métallique



1019
Sablé Métallique



2100
Noir

Toile



Sable
blanc



Peau



Luxure
blanche



Gris



Moka



Ébène

DIMENSIONS

Différentes dimensions possibles :

L. 780 x P. 1970 x H. 540 mm

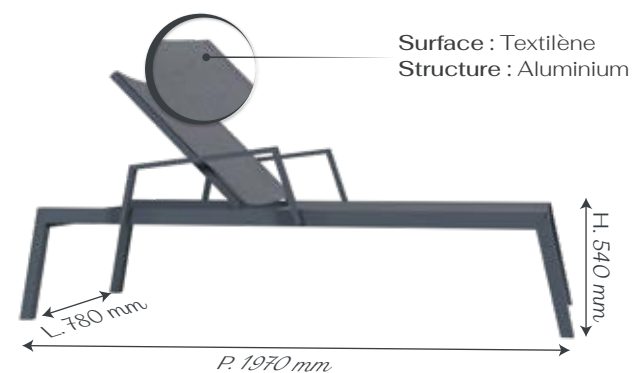

L. 780 x P. 1970 x H. 300 mm

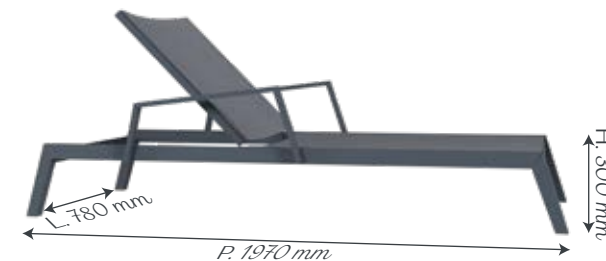



ACORES | Bain de soleil et dessert en aluminium



CARACTÉRISTIQUES

- Bain de soleil en aluminium et textilène
- Desserte en aluminium
- Aluminium thermolaqué Qualicoat / Qualimarine / Qualanod

COULEURS DISPONIBLES

<i>Structure</i>	 9016 Blanc	 7016 Gris anthracite	 7036 Gris Métallique	 1019 Sablé Métallique	 2100 Noir	
<i>Toile</i>	 Sable blanc	 Peau	 Luxure blanche	 Gris	 Moka	 Ébène

DIMENSIONS

Réf. Bain de soleil Acores

L. 2020 x P. 925 x H. 300 mm

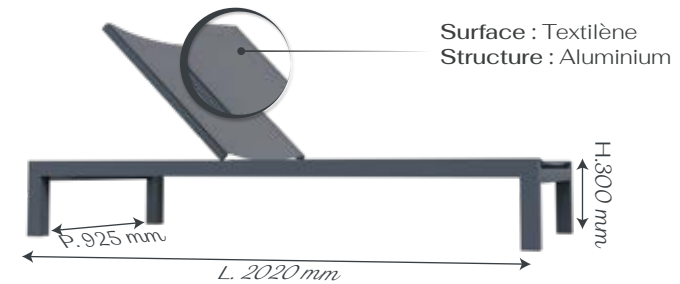

Réf. Desserte Acores

L. 380 x P. 380 x H. 560 mm

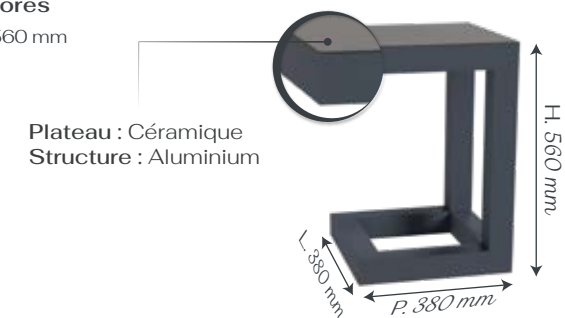





SOFA & POLTRONA | Salon de jardin

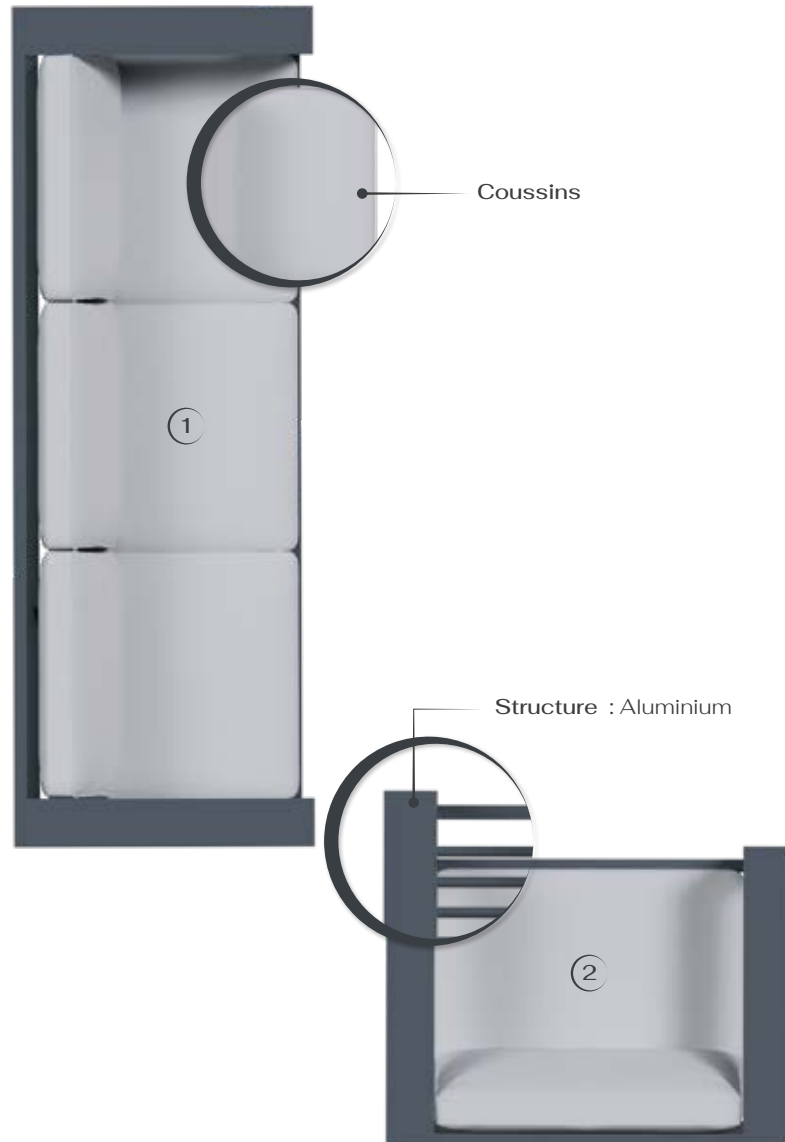

CARACTÉRISTIQUES

- Salon de jardin modulable en aluminium
- Aluminium thermolaqué Qualicoat / Qualimarine / Qualanod

1. **Réf. Sofa** : Canapé 3 places
 - 6 coussins de décoration inclus
 - Vendue à l'unité

2. **Réf. Poltrona** : Fauteuils 1 place
 - 2 coussins de décoration inclus
 - Vendue à l'unité

Réf. Table bela sofa

- Table basse fixe rectangulaire
- Plateau en céramique
- Vendue à l'unité

COULEURS DISPONIBLES

Structure



9016
Blanc



7016
Gris anthracite



7036
Gris Métallique



1019
Sablé Métallique



2100
Noir

Coussin



Blanc

DIMENSIONS

Réf. Sofa

L. 2305 x P. 850 x H. 650 mm



Réf. Poltrona

L. 955 x P. 850 x H. 650 mm

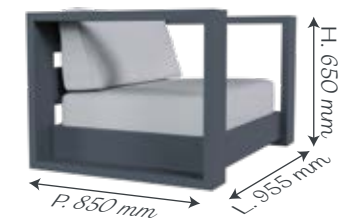

Réf. Table bela sofa

L. 760 x P. 1400 x H. 400 mm

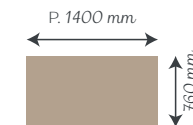



BRIC À BRAC M | Coffre de rangement



CARACTÉRISTIQUES

- Coffre de rangement en aluminium
- Coffre pratique, isolé, étanche et robuste afin d'optimiser votre organisation et vos rangements, grâce à ces lignes contemporaines.
- Mur en panneau isolé mousse polyuréthane haute densité 40 mm
- Parement gris lisse en acier laqué et nervuré blanc coté intérieure
- Double vérins

COULEURS

Extérieure



Intérieur



DIMENSIONS

L. 1200 x P. 610 x H. 620 mm





BRIC À BRAC L | Coffre de rangement



CARACTÉRISTIQUES

- Coffre de rangement en aluminium
- Coffre pratique, isolé, étanche et robuste afin d'optimiser votre organisation et vos rangements, grâce à ces lignes contemporaines.
- Mur en panneau isolé mousse polyuréthane haute densité 40 mm
- Parement gris lisse en acier laqué et nervuré blanc coté intérieure
- Double vérins

COULEURS

Extérieure



Intérieur



DIMENSIONS

L. 1650 x P. 700 x H. 620 mm





COFFRE DE RANGEMENT XL



CARACTÉRISTIQUES

- Abris pratique, isolé, étanche et robuste afin d'optimiser votre organisation et vos rangements, grâce à ces lignes contemporaines.
- Parois en panneau isolé mousse polyuréthane haute densité 40 mm
- Parement gris lisse en acier laqué et nervuré blanc coté intérieure
- Double vérins
- Nous vous conseillons de poser systématiquement une double grille d'aération pour chaque abris

COULEURS

Extérieure



Intérieur



DIMENSIONS

L. 2000 x P. 1000 x H. 1500 mm







PEQUENO ET BONITO | Chauffage terrasse à pellet



CARACTÉRISTIQUES

- Chauffage de terrasse à pellet permettant de profiter pleinement de votre extérieur en toutes saisons. Équipé d'un boîtier de contrôle automatique de la combustion, il permet d'obtenir un excellent rendement énergétique.
- Structure en acier
- Combustible : granulés de bois
- Réservoir de granulés de 1,5 L
- Puissance : 1,5 kw
- Autonomie 1 h
- Poids : 8 Kg

COULEURS



7016
Sablé

DIMENSIONS

L. 252 x P. 260 x H. 342 mm

Structure : Acier

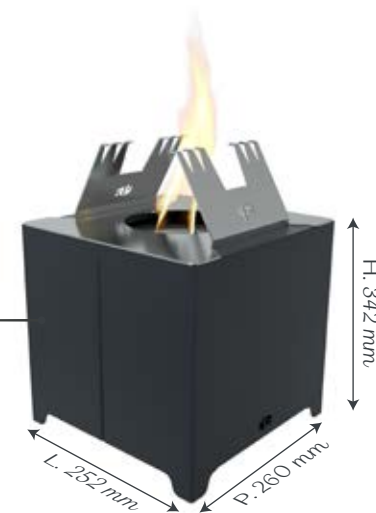



MEDIO ET BONITO | Chauffage terrasse à pellet



CARACTÉRISTIQUES

- Chauffage de terrasse à pellet permettant de profiter pleinement de votre extérieur en toutes saisons. Équipé d'un boîtier de contrôle automatique de la combustion, il permet d'obtenir un excellent rendement énergétique.
- Structure en acier
- Combustible : granulés de bois
- Réservoir de granulés de 7 L
- Puissance : 4 kw
- Autonomie 140 min
- Poids : 27 Kg

COULEURS



7016
Sable

DIMENSIONS

L. 450 x P. 450 x H. 775 mm

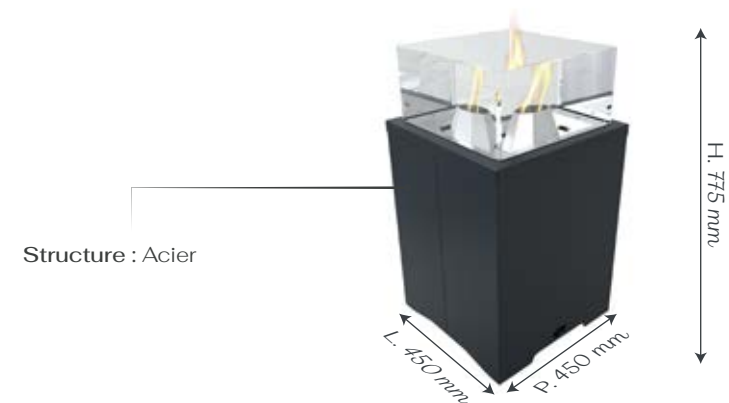



GRANDISSIMO ET BONITO | Chauffage terrasse à pellet



CARACTÉRISTIQUES

- Chauffage de terrasse à pellet permettant de profiter pleinement de votre extérieur en toutes saisons. Équipé d'un boîtier de contrôle automatique de la combustion, il permet d'obtenir un excellent rendement énergétique.
- Structure en acier
- Combustible : granulés de bois
- Réservoir de granulés de 15 L
- Puissance : 12 kw
- Autonomie 200 min
- Poids : 60 Kg

COULEURS



7016
Sablé

DIMENSIONS

L. 461 x P. 461 x H. 2259 mm

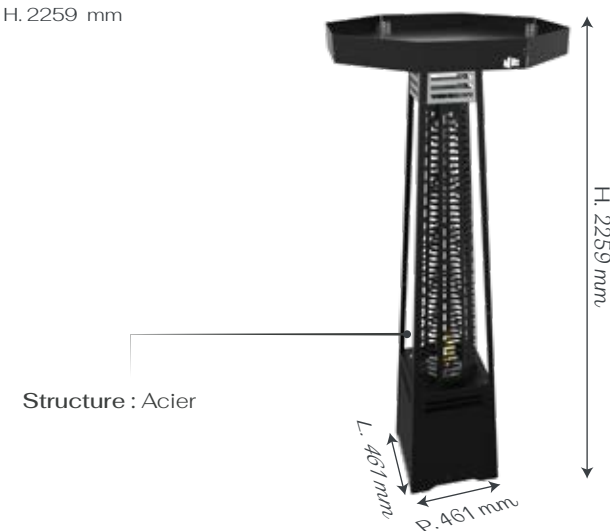

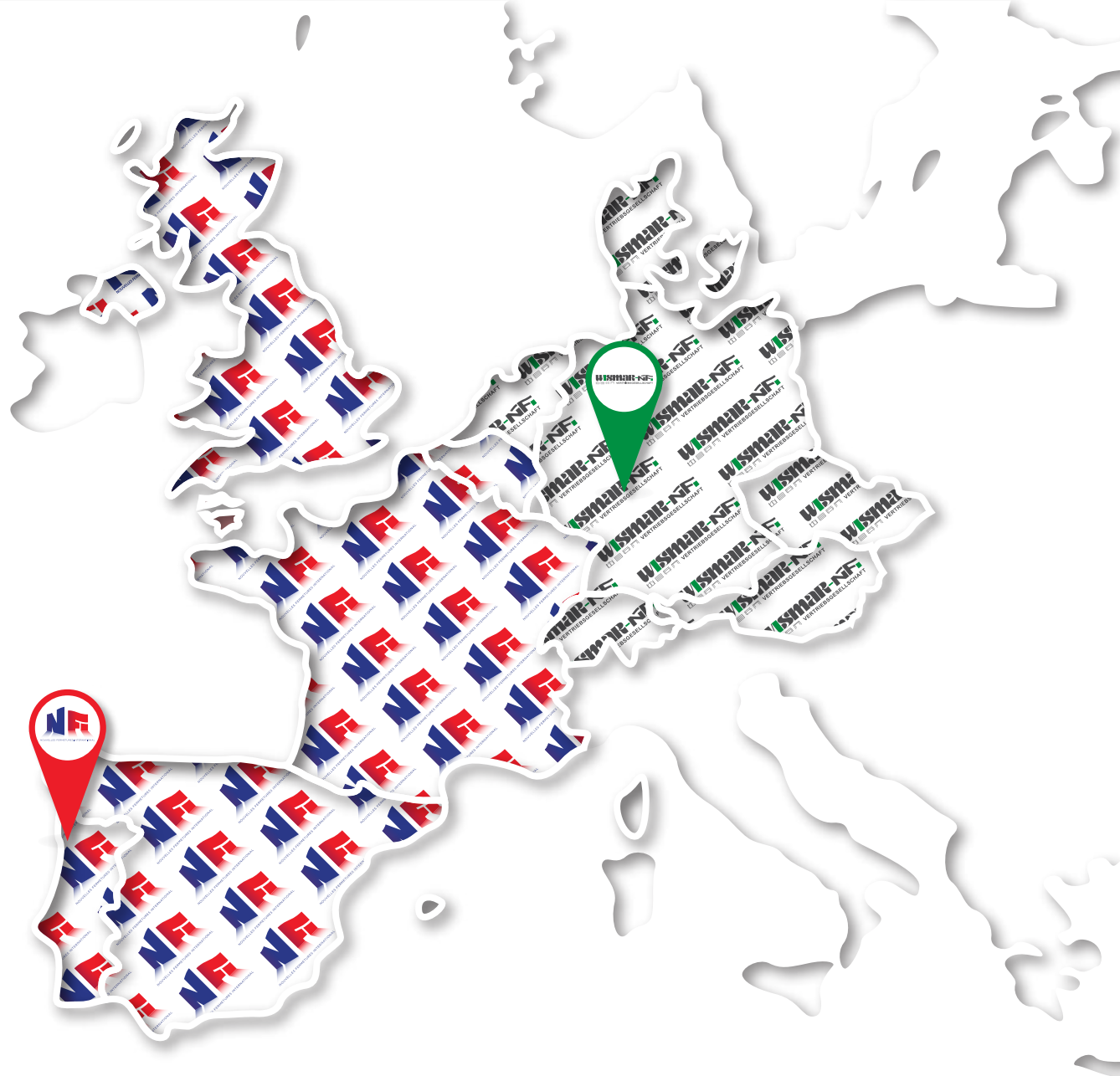

Alu-made by 

www.nfi.pt

Rua da Braziela, n°51 Fradelos
4760 – 564 Vila Nova de Famalicão, Portugal
06 25 57 24 36 - (00 351) 252 412 734
commerce@nfi.pt



Wismar-NFI Vertriebs GmbH
Robert- Bosch- Str. 2
D- 68542 Heddesheim, Deutschland
06203-40440 - info@wismar-nfi.de

